



# Pan-American Cadet Championships 2019

(COL Cali, 19 July 2019)

## -50 kg

9 Judoka

POOL A

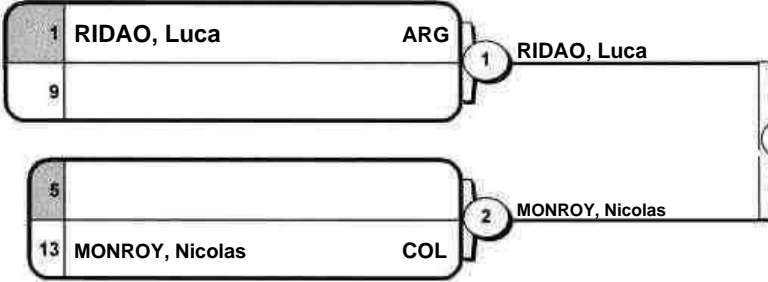

POOL B

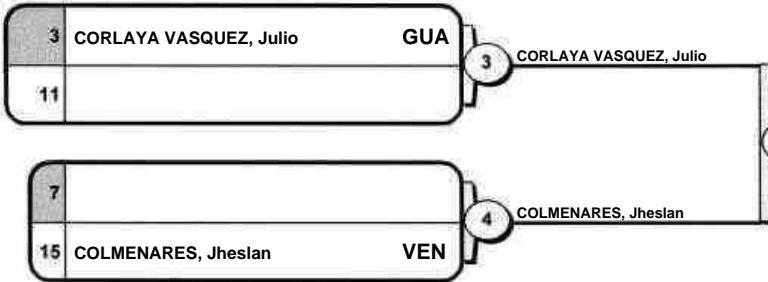

POOL C

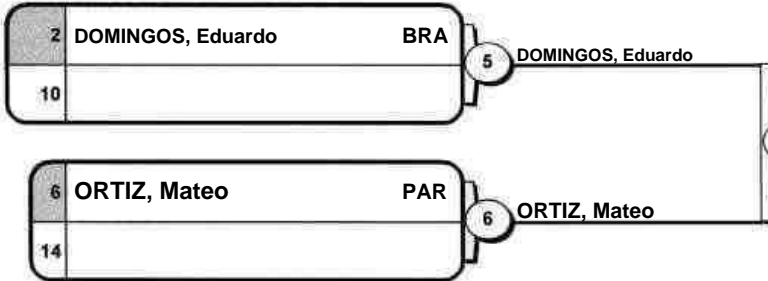

POOL D

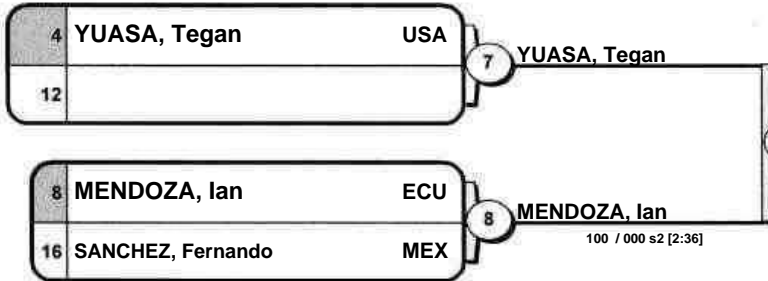

COLMENARES, Jheslan (23) 010 s2 / 000 [4:00]

1.

DOMINGOS, Eduardo (18) 100 / 000 sH [2:56]

### Results Résultat / Platzierungen

- |    |                        |     |
|----|------------------------|-----|
| 1. | COLMENARES, Jheslan    | VEN |
| 2. | DOMINGOS, Eduardo      | BRA |
| 3. | MENDOZA, Ian           | ECU |
| 3. | RIDAO, Luca            | ARG |
| 5. | CORLAYA VASQUEZ, Julio | GUA |
| 5. | YUASA, Tegan           | USA |
| 7. | MONROY, Nicolas        | COL |
| 7. | ORTIZ, Mateo           | PAR |

Repechage / Trostrunde

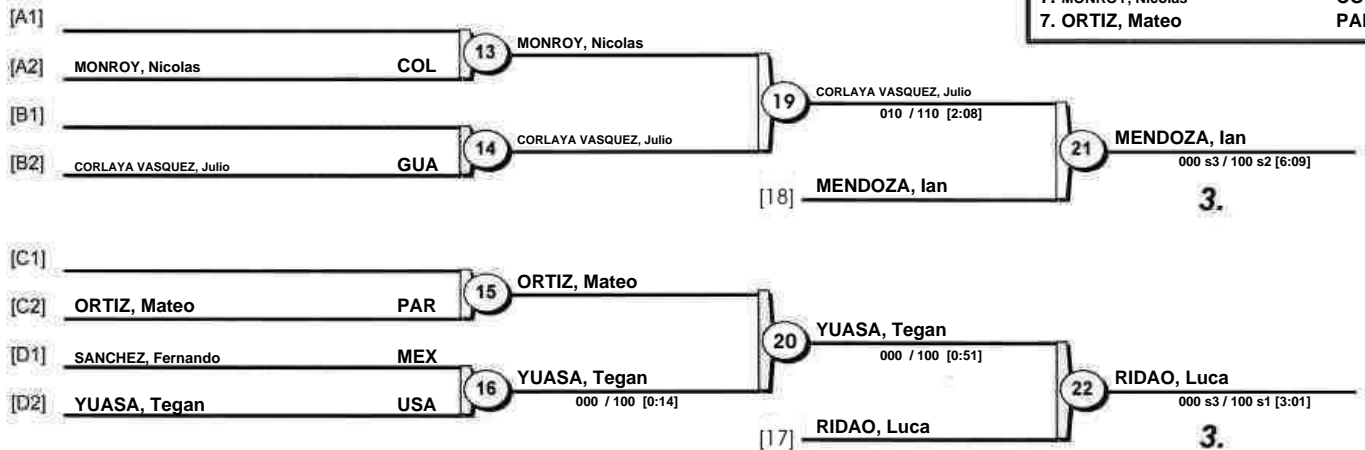



# Pan-American Cadet Championships 2019

(COL Cali, 19 July 2019)

## -55 kg

14 Judoka

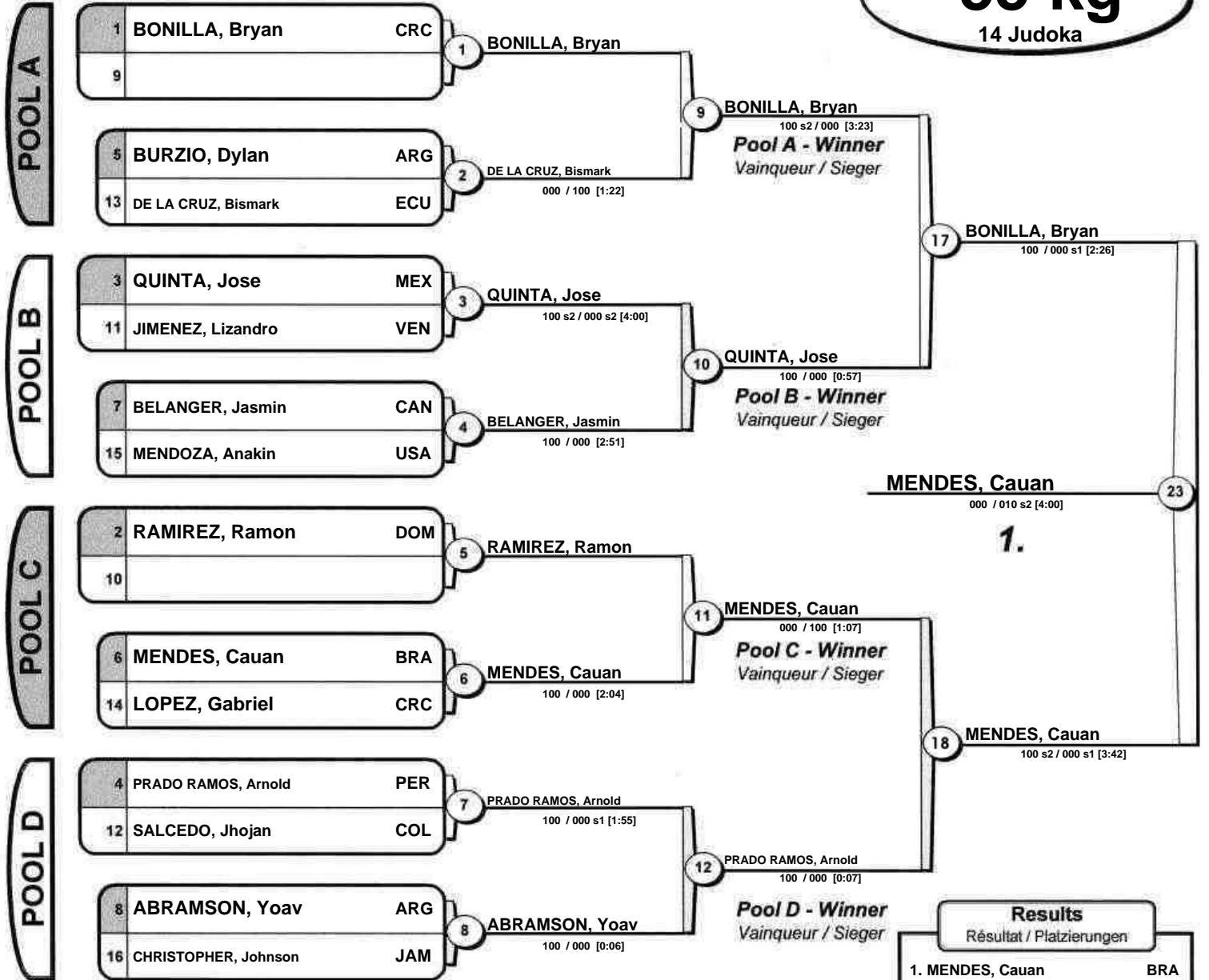

Results	
Résultat / Platzierungen	
1. MENDES, Cauan	BRA
2. BONILLA, Bryan	CRC
3. DE LA CRUZ, Bismark	ECU
3. QUINTA, Jose	MEX
5. PRADO RAMOS, Arnold	PER
5. SALCEDO, Jhojan	COL
7. JIMENEZ, Lizandro	VEN
7. LOPEZ, Gabriel	CRC

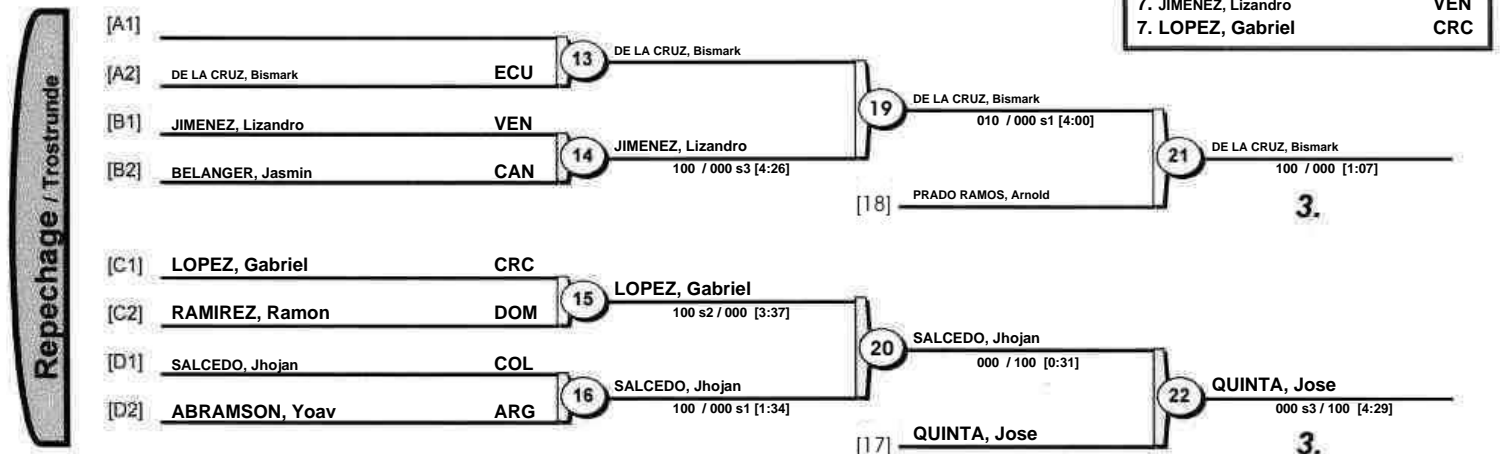



# Pan-American Cadet Championships 2019

(COL Cali, 19 July 2019)

## -60 kg

15 Judoka

POOL A

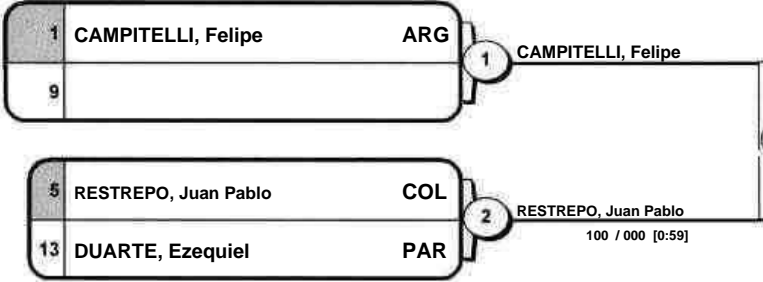

POOL B

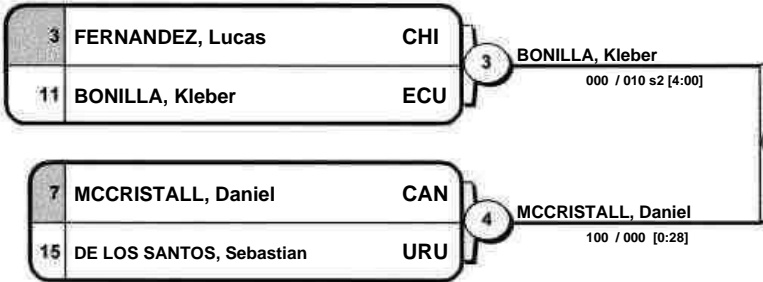

POOL C

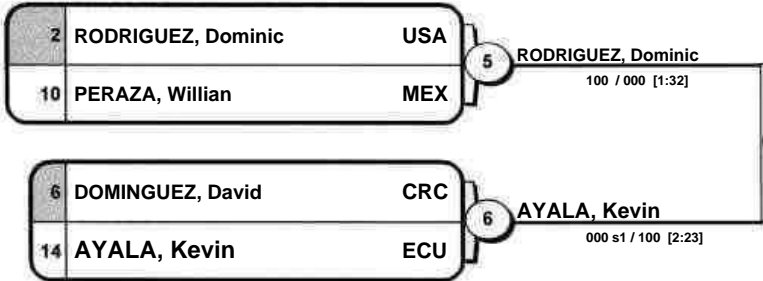

POOL D

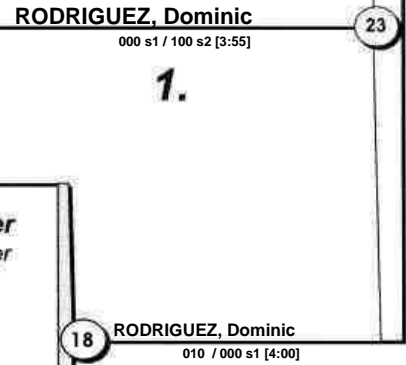
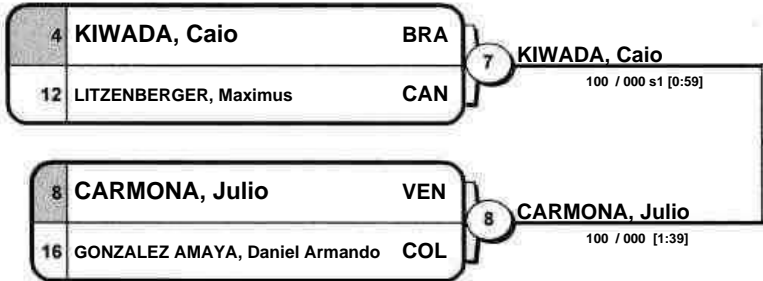

Results	
Résultat / Platzierungen	
1.	RODRIGUEZ, Dominic USA
2.	RESTREPO, Juan Pablo COL
3.	KIWADA, Caio BRA
3.	AYALA, Kevin ECU
5.	CAMPITELLI, Felipe ARG
5.	BONILLA, Kleber ECU
7.	FERNANDEZ, Lucas CHI
7.	LITZENBERGER, Maximus CAN

Repechage / Trostrunde

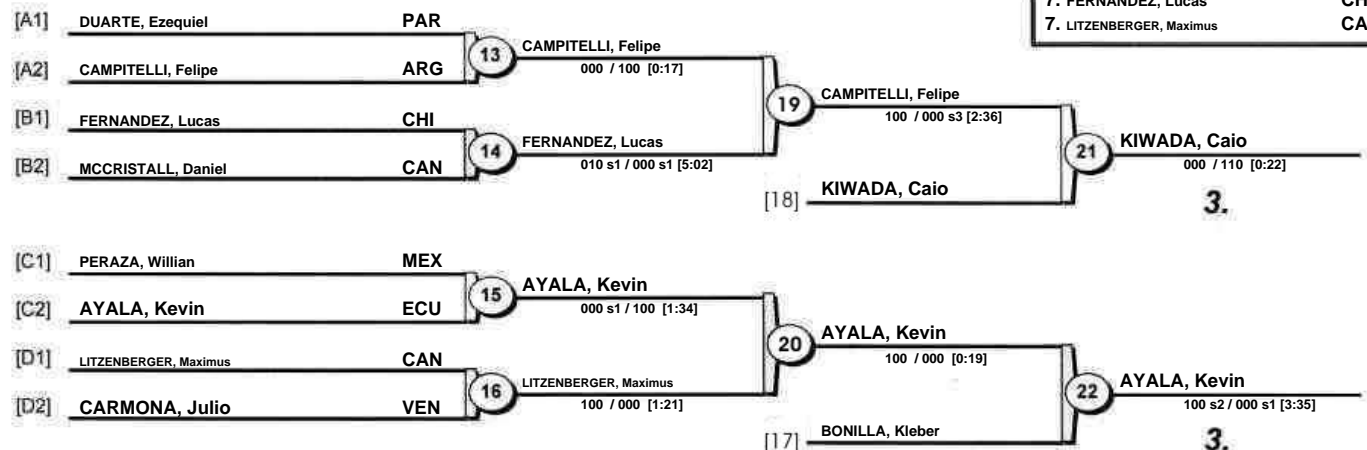



# Pan-American Cadet Championships 2019

(COL Cali, 19 July 2019)

## -66 kg

17 Judoka

POOL A



POOL B

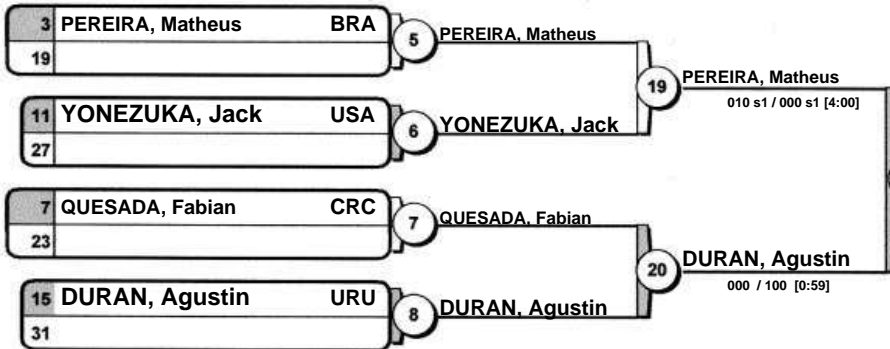

POOL C



POOL D



MEJIA, Mateo

37 PEREIRA, Matheus  
000 / 100 s1 [3:36]

43  
000 s1 / 100 s1 [3:08]

1.

38 MEJIA, Mateo  
100 / 000 [0:50]

### Results

Résultat / Platzierungen

1. MEJIA, Mateo COL
2. PEREIRA, Matheus BRA
3. YONEZUKA, Jack USA
5. CUSI HUACHACA, Julio Cesar PER
5. LOPEZ, Fransisco ARG
7. GONZALEZ, Erick MEX
7. POPOVICI, David CAN

Repechage / Trostrunde

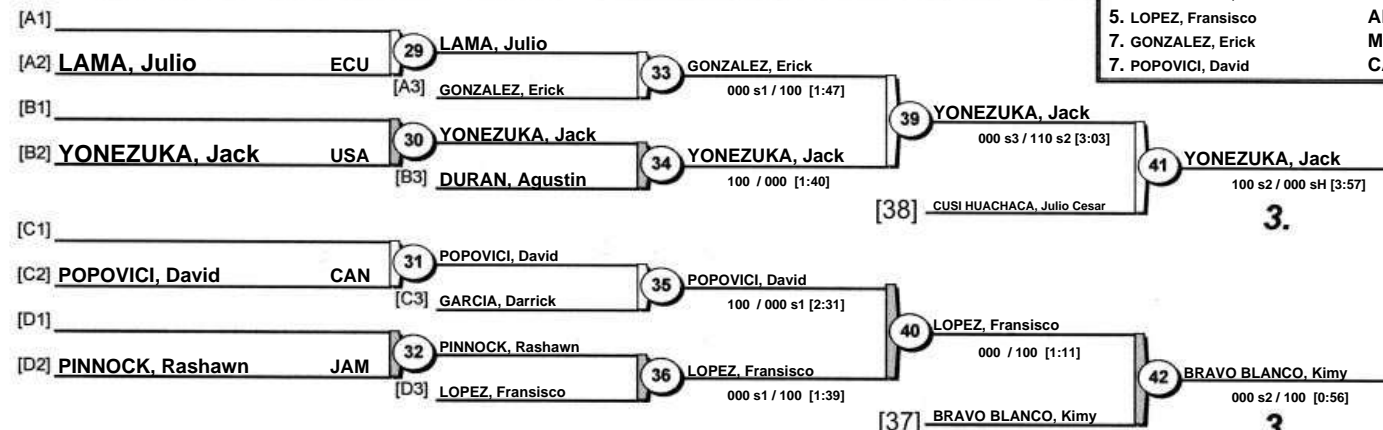



# Pan-American Cadet Championships 2019

(COL Cali, 19 July 2019)

## -73 kg

16 Judoka

POOL A

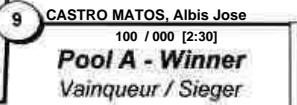
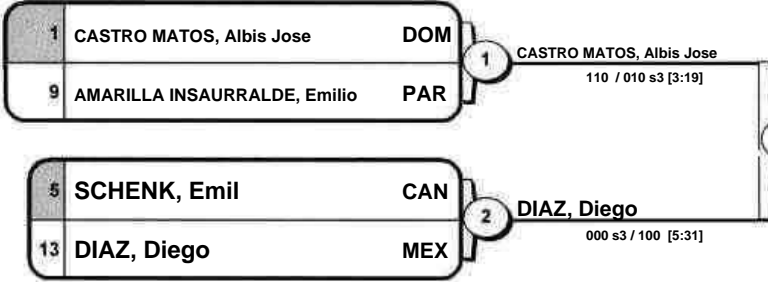

POOL B

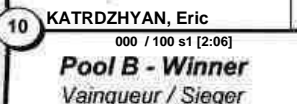
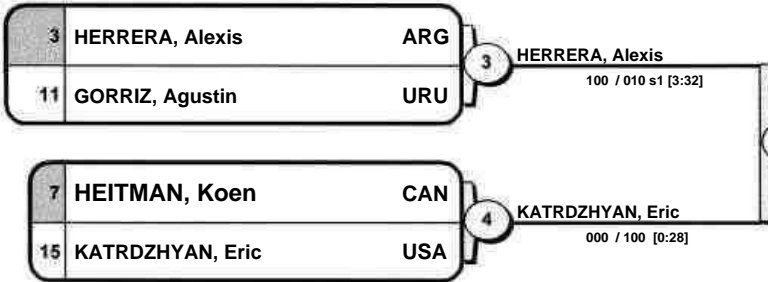

POOL C

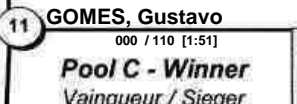

POOL D

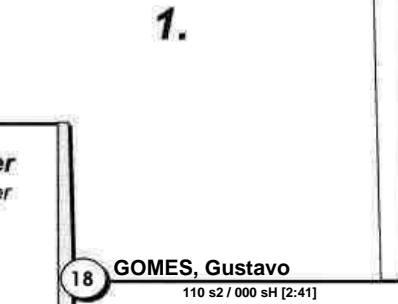
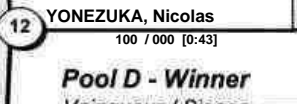
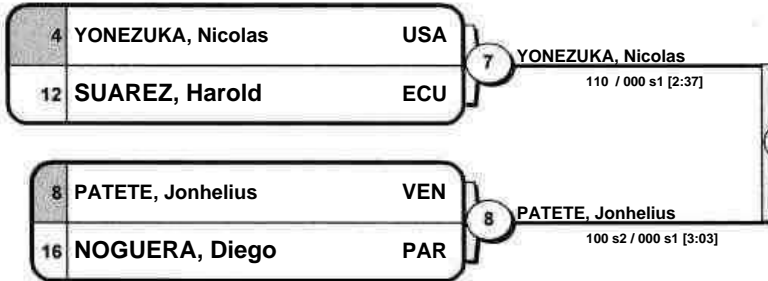

Results	
Résultat / Platzierungen	
1. GOMES, Gustavo	BRA
2. KATRDZHYAN, Eric	USA
3. YONEZUKA, Nicolas	USA
3. DEL BIONDO, Matias	ARG
5. DIAZ, Diego	MEX
5. CASTRO MATOS, Albis Jose	DOM
7. HERRERA, Alexis	ARG
7. SUAREZ, Harold	ECU

Repechage / Trostrunde

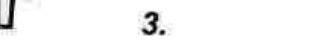
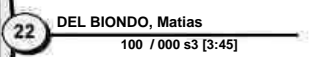
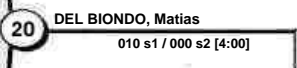
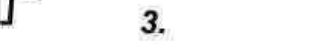
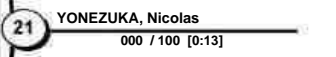
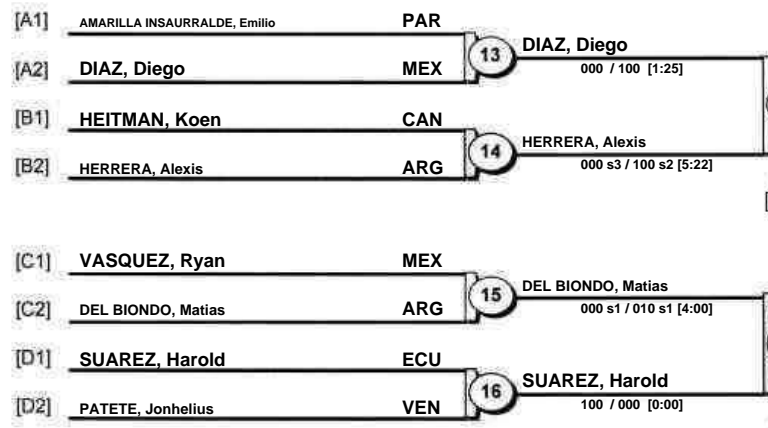



# Pan-American Cadet Championships 2019

(COL Cali, 19 July 2019)

## -81 kg

10 Judoka

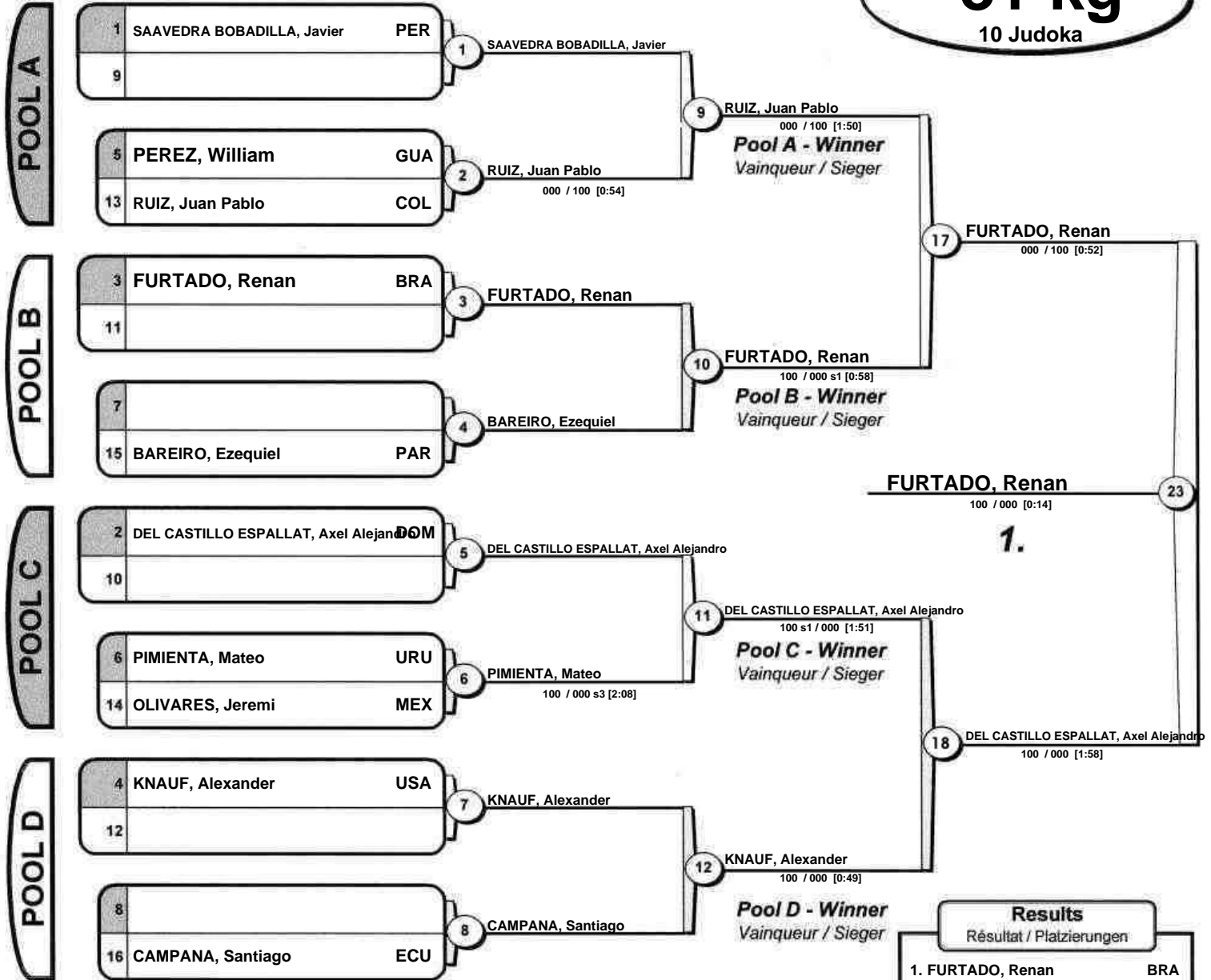

Results		
Résultat / Platzierungen		
1.	FURTADO, Renan	BRA
2.	DEL CASTILLO ESPALLAT, Axel Alejandro	DOM
3.	KNAUF, Alexander	USA
3.	RUIZ, Juan Pablo	COL
5.	SAAVEDRA BOBADILLA, Javier	PER
5.	PIMIENTA, Mateo	URU
7.	BAREIRO, Ezequiel	PAR
7.	CAMPANA, Santiago	ECU

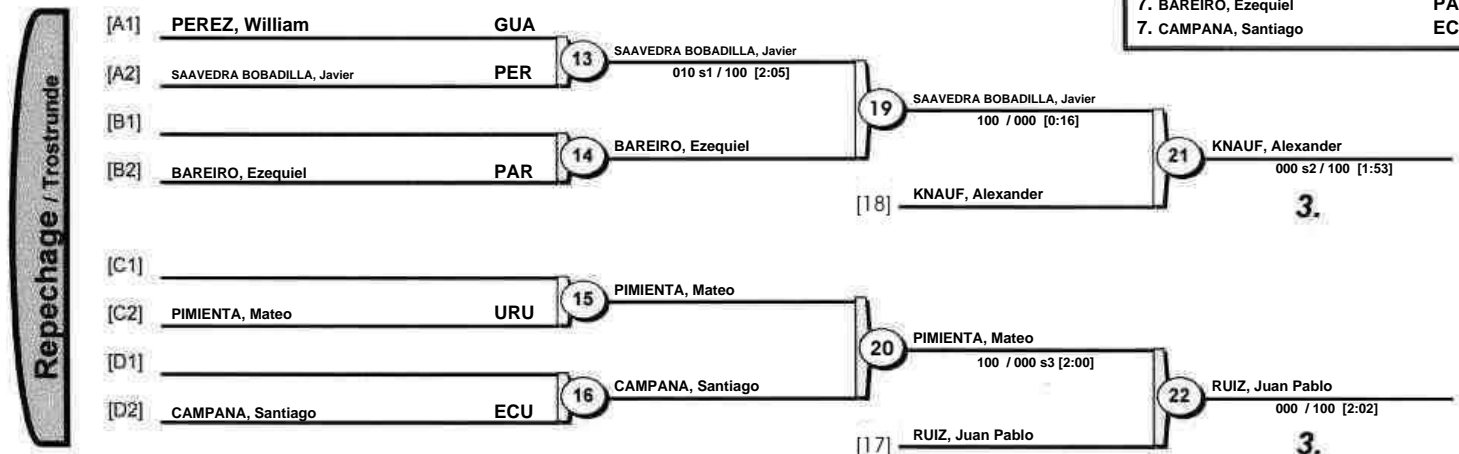



# Pan-American Cadet Championships 2019

(COL Cali, 19 July 2019)

## -90 kg

8 Judoka

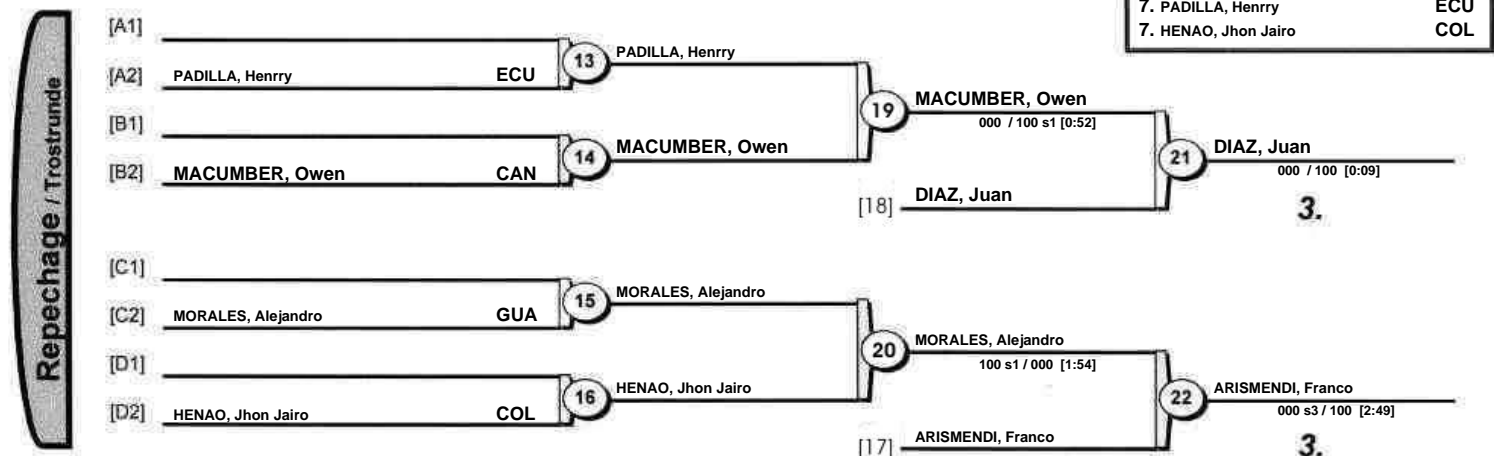
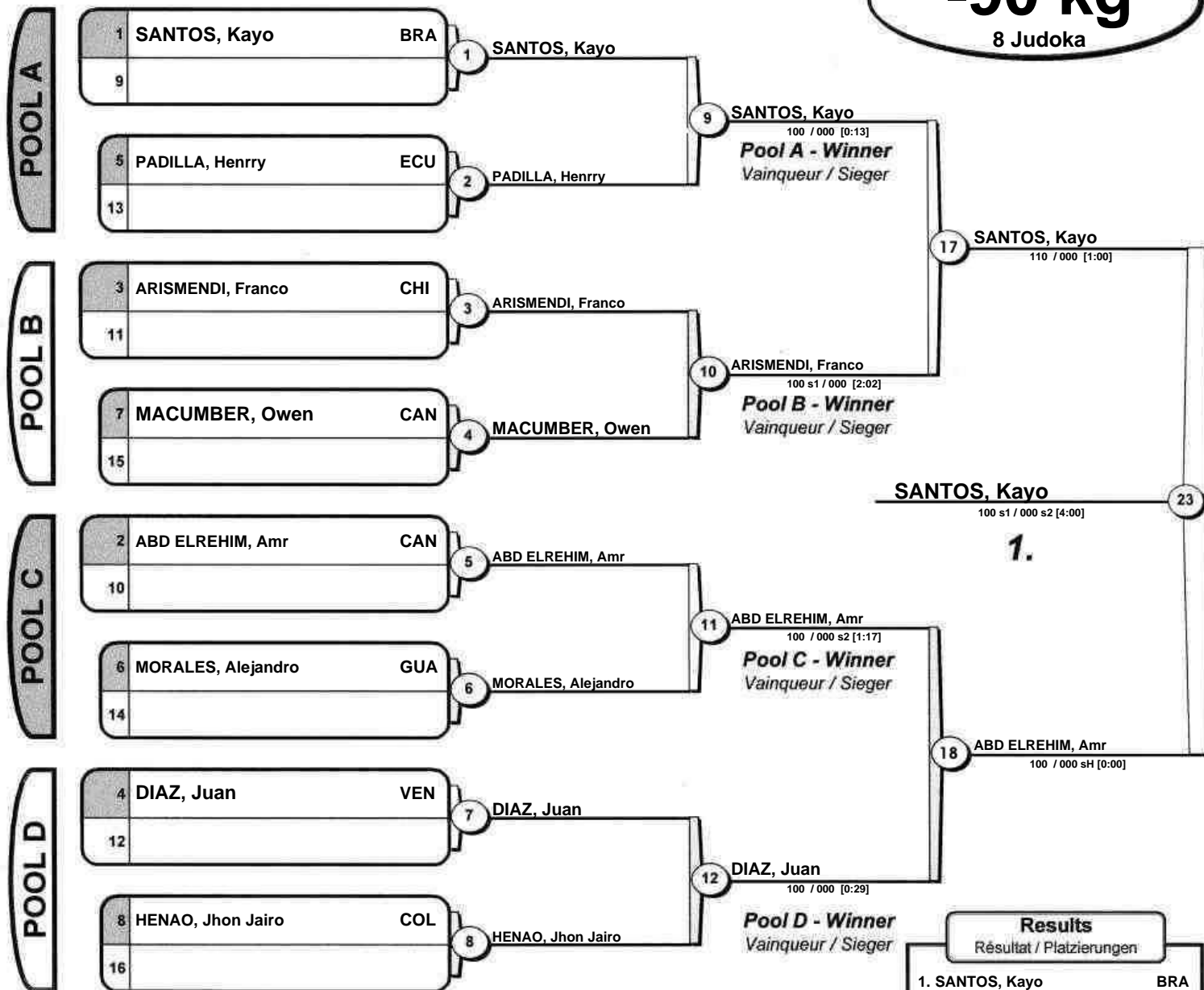



# Pan-American Cadet Championships 2019

(COL Cali, 19 July 2019)

## +90 kg

5 Judoka

			1	3	5		
1	WILLIAMS, Andrew	USA		-	-	0 (0)	
3	OREJUELA, Elmer	COL	✚ <sub>10</sub>		-	1 (10)	
5	ROSA, Bernardo	BRA	✚ <sub>10</sub>	✚ <sub>10</sub>		2 (10)	

			2	4		
2	JARA, Jose Ignacio	CHI		-		
4	GRIGORIAN, Thomas	USA	✚ <sub>10</sub>			

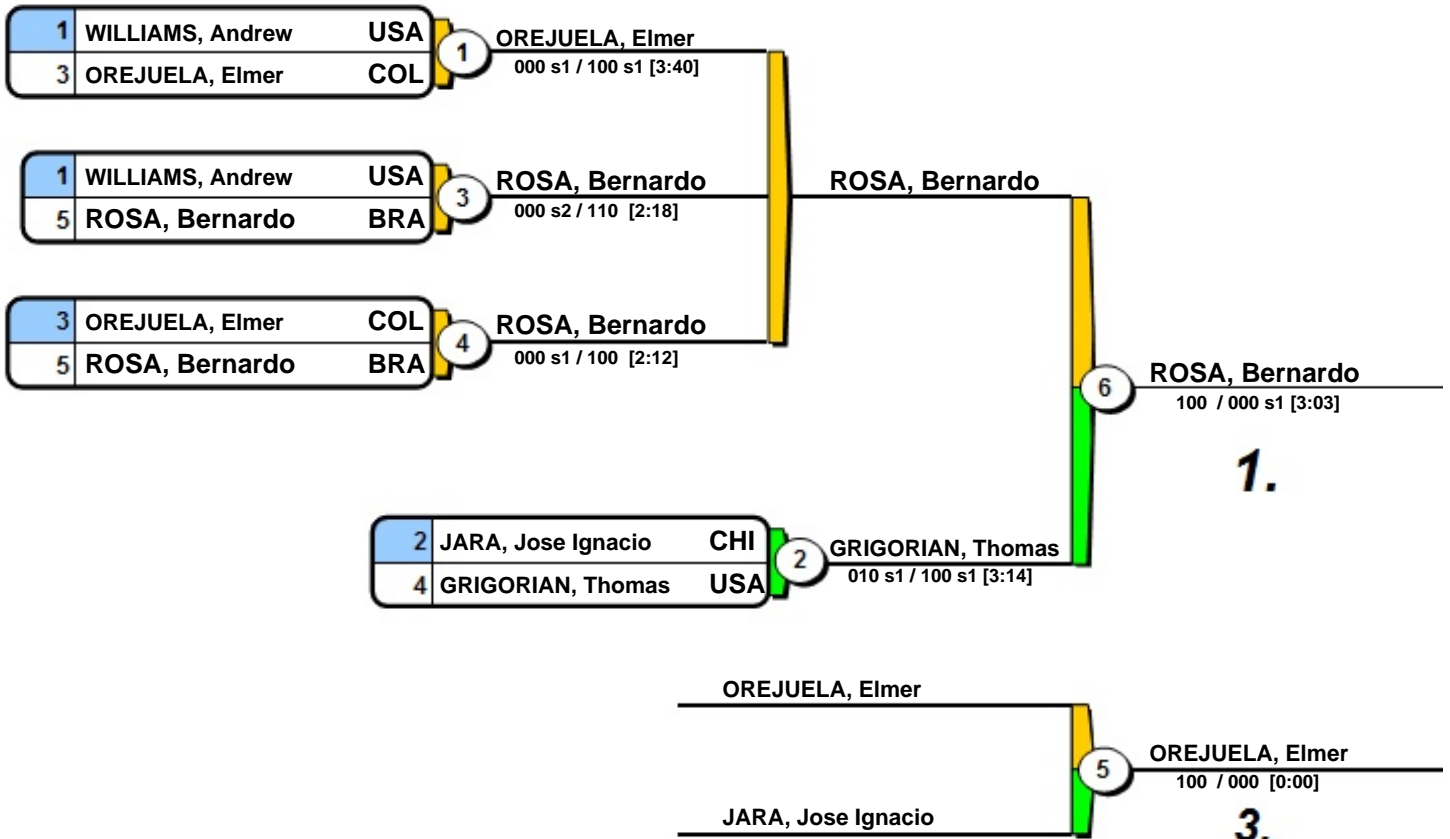

## Final Results

- ROSA, Bernardo BRA
- GRIGORIAN, Thomas USA
- OREJUELA, Elmer COL





# Pan-American Cadet Championships 2019

(COL Cali, 19 July 2019)

# -40 kg

5 Judoka

			1	3	5		
1	TORRO, Luchia	USA		+	+	2 (17)	
3	ROMERO, Angelica	ECU	-		+	1 (10)	
5	DIAZ, Diana Lizeth	COL	-	-		0 (0)	

			2	4		
2	VENCESLAU, Rebeka	BRA		+		
4	DE LA CRUZ, Amanda	ECU	-			

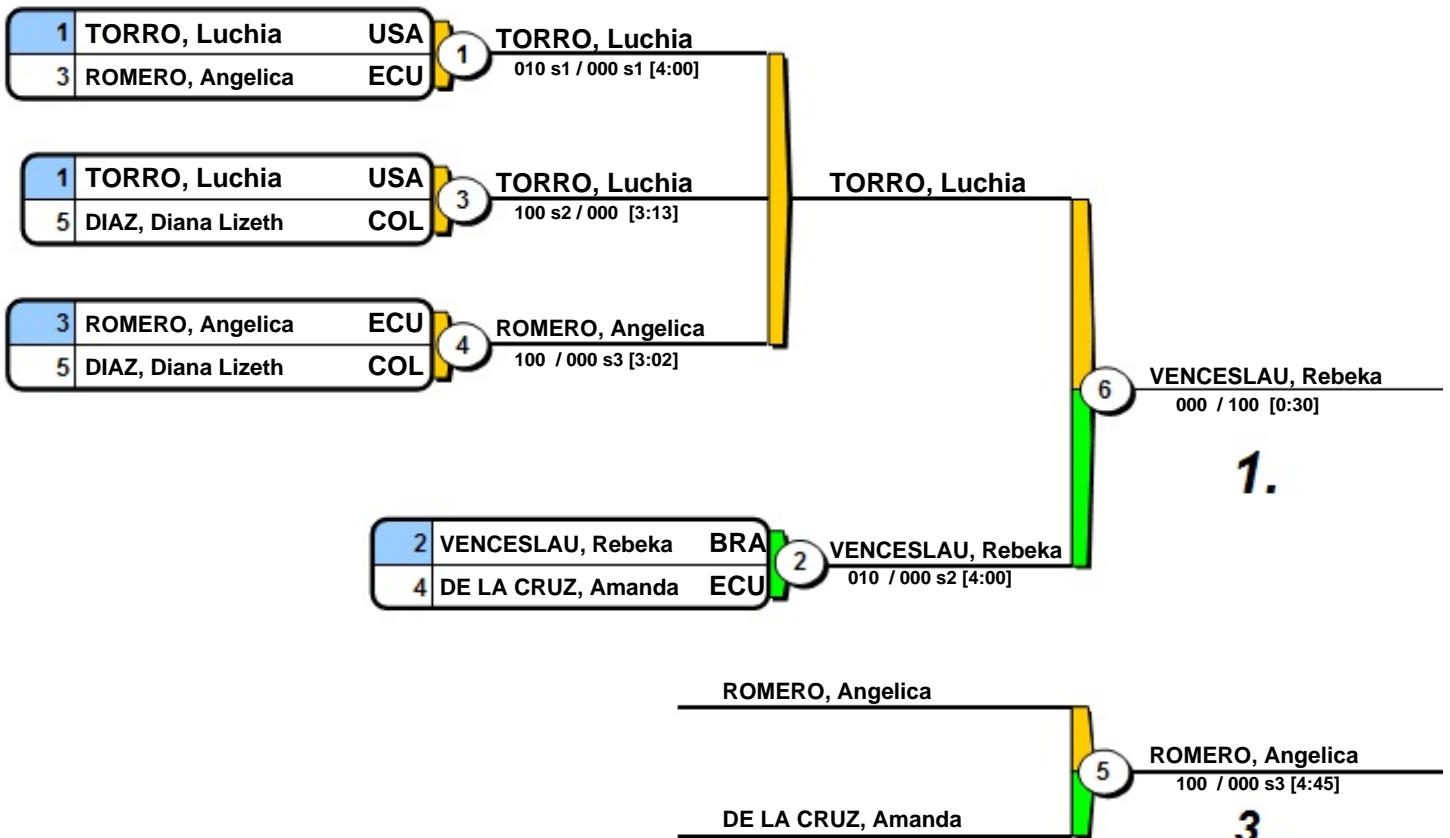

## Final Results

- VENCESLAU, Rebeka (BRA)
- TORRO, Luchia (USA)
- ROMERO, Angelica (ECU)



# Pan-American Cadet Championships 2019

(COL Cali, 19 July 2019)

# -44 kg

10 Judoka

POOL A

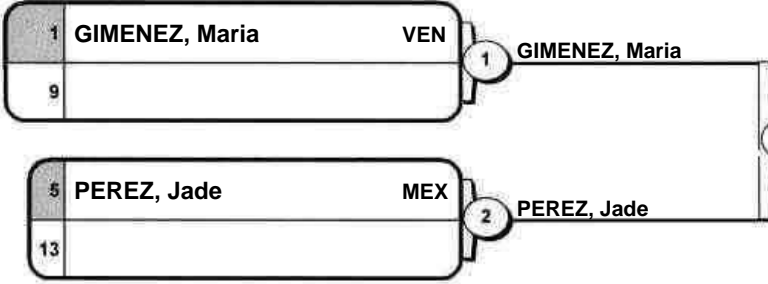

POOL B

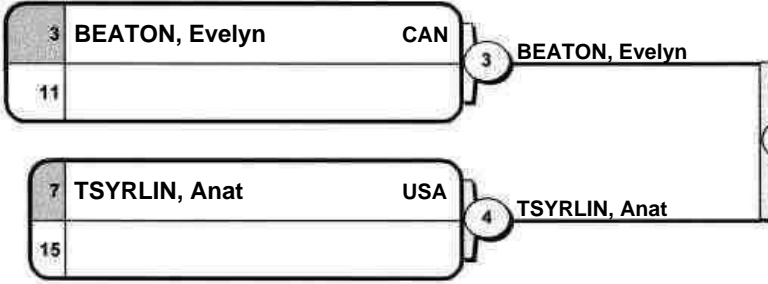

POOL C

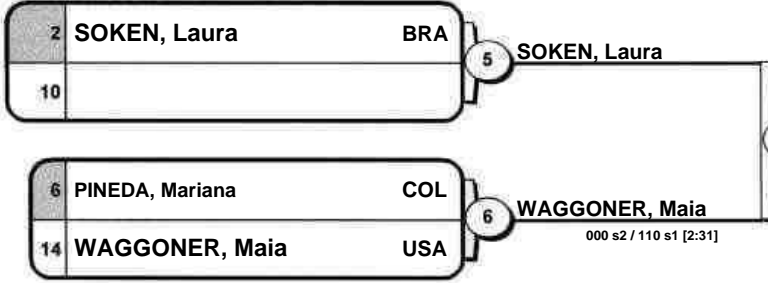

POOL D

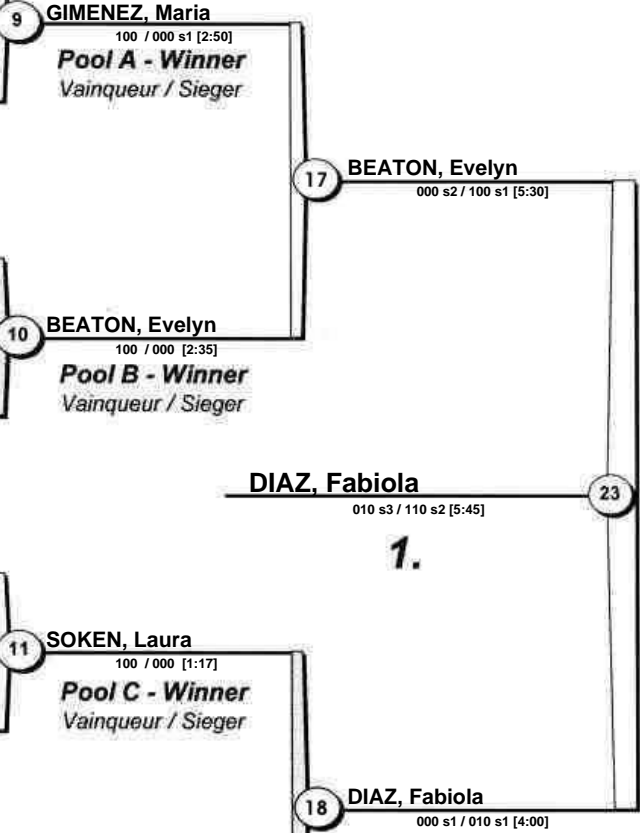
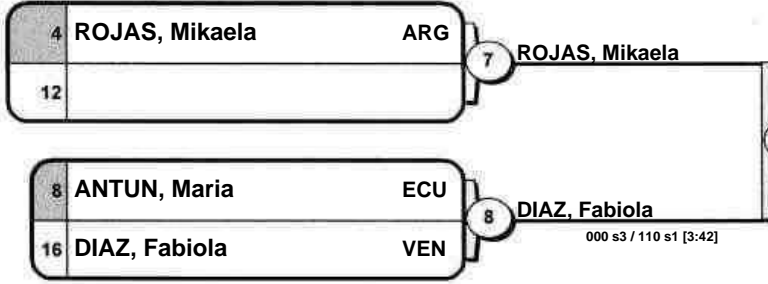

DIAZ, Fabiola

010 s3 / 110 s2 [5:45]

1.

Results	
Résultat / Platzierungen	
1.	DIAZ, Fabiola VEN
2.	BEATON, Evelyn CAN
3.	SOKEN, Laura BRA
3.	ROJAS, Mikaela ARG
5.	PÉREZ, Jade MEX
5.	GIMENEZ, Maria VEN
7.	TSYRLIN, Anat USA
7.	WAGGONER, Maia USA

Repechage / Trostrunde

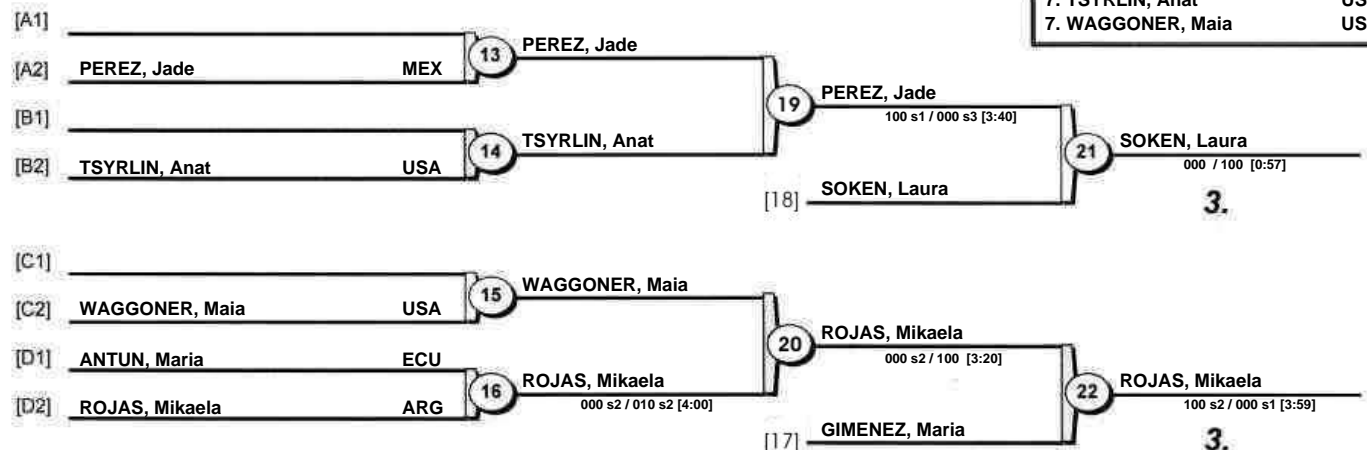



# Pan-American Cadet Championships 2019

(COL Cali, 19 July 2019)

## -48 kg

10 Judoka

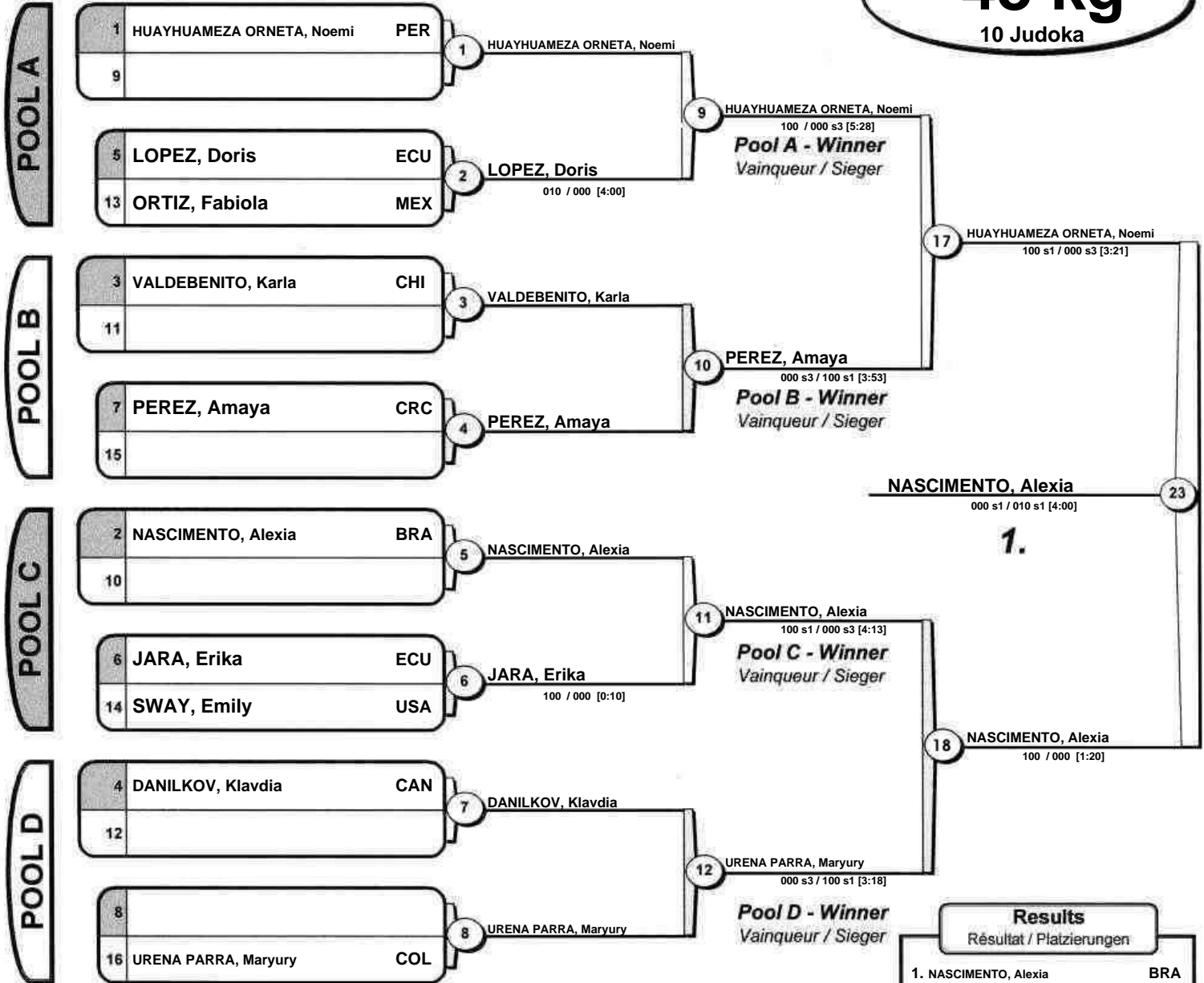

Results		
Résultat / Platzierungen		
1.	NASCIMENTO, Alexia	BRA
2.	HUAYHUAMEZA ORNETA, Noemi	PER
3.	URENA PARRA, Maryury	COL
3.	DANILKOV, Klavdia	CAN
5.	LOPEZ, Doris	ECU
5.	PEREZ, Amaya	CRC
7.	VALDEBENITO, Karla	CHI
7.	JARA, Erika	ECU

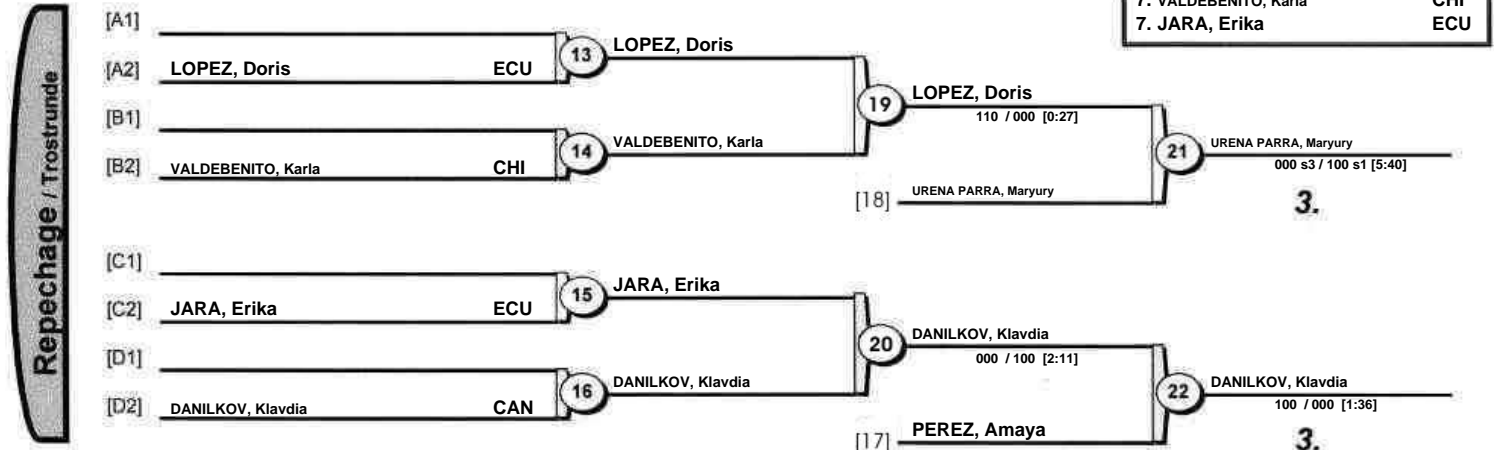



# Pan-American Cadet Championships 2019

(COL Cali, 19 July 2019)

## -52 kg

14 Judoka

POOL A

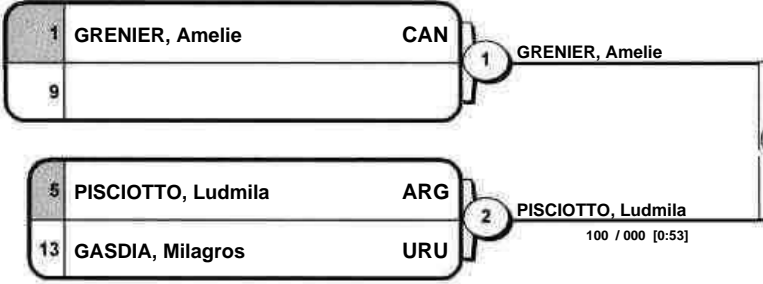

POOL B

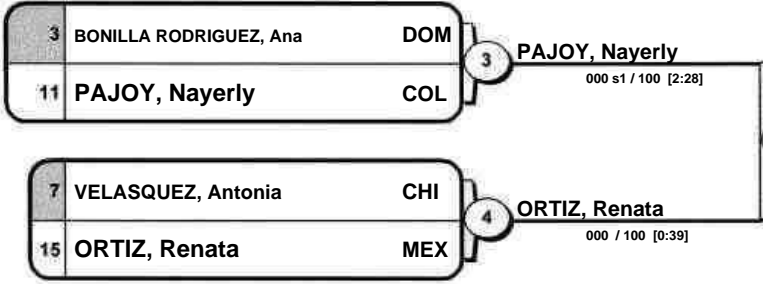

POOL C

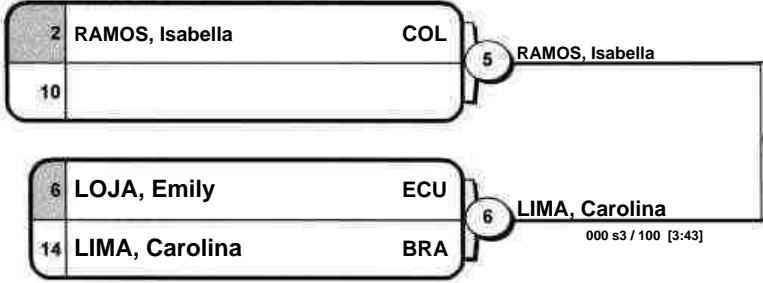

POOL D

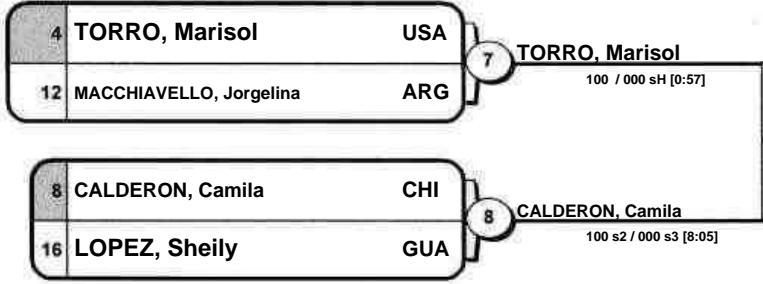

TORRO, Marisol

000 / 010 s2 [4:00]

1.



Results	
Résultat / Platzierungen	
1. TORRO, Marisol	USA
2. PAJOY, Nayerly	COL
3. ORTIZ, Renata	MEX
3. PISCOTTO, Ludmila	ARG
5. LIMA, Carolina	BRA
5. LOJA, Emily	ECU
7. GRENIER, Amelie	CAN
7. CALDERON, Camila	CHI

Repechage / Trostrunde

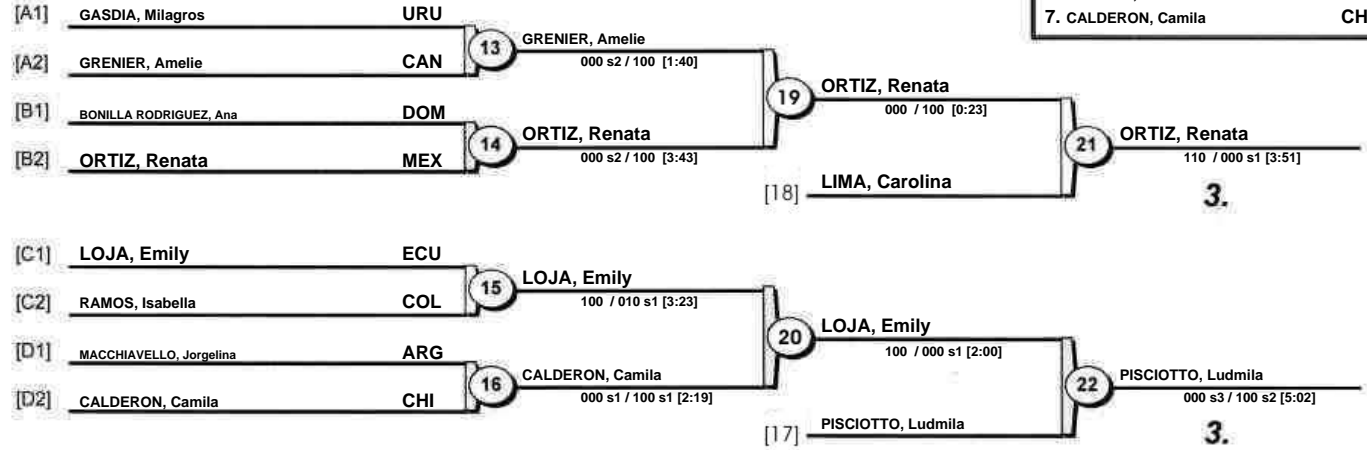



# Pan-American Cadet Championships 2019

(COL Cali, 19 July 2019)

## -57 kg

10 Judoka

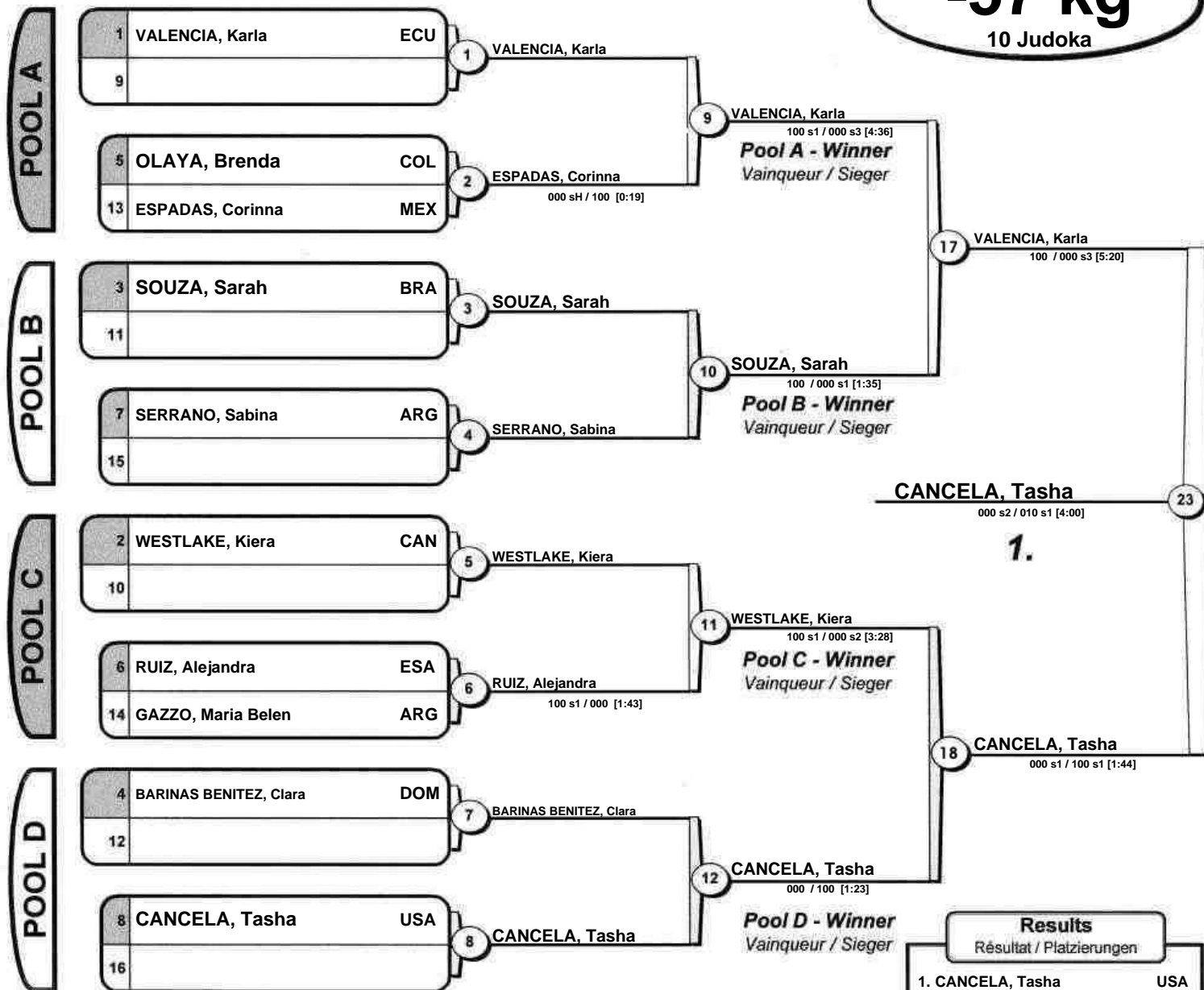

Results	
Résultat / Platzierungen	
1. CANCELA, Tasha	USA
2. VALENCIA, Karla	ECU
3. WESTLAKE, Kiera	CAN
3. SOUZA, Sarah	BRA
5. ESPADAS, Corinna	MEX
5. BARINAS BENITEZ, Clara	DOM
7. SERRANO, Sabina	ARG
7. RUIZ, Alejandra	ESA

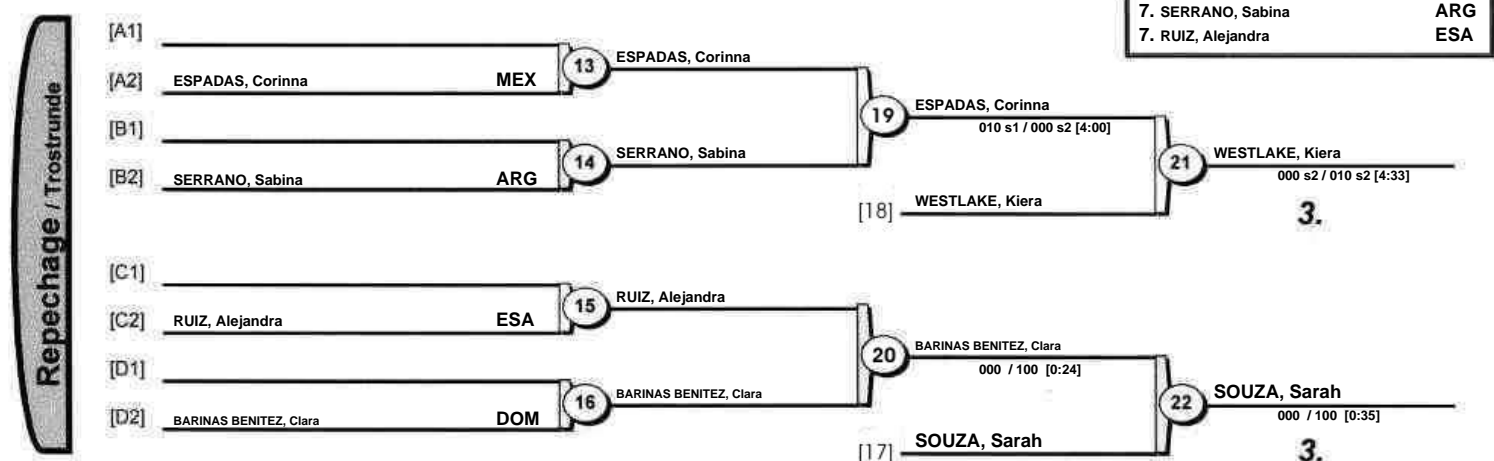



# Pan-American Cadet Championships 2019

(COL Cali, 19 July 2019)

## -63 kg

12 Judoka

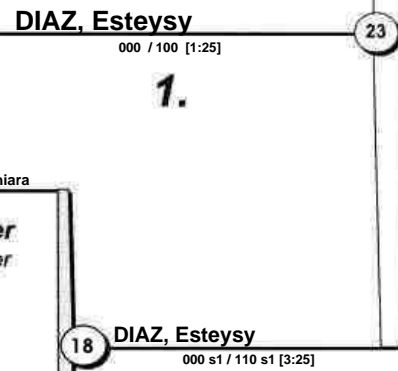
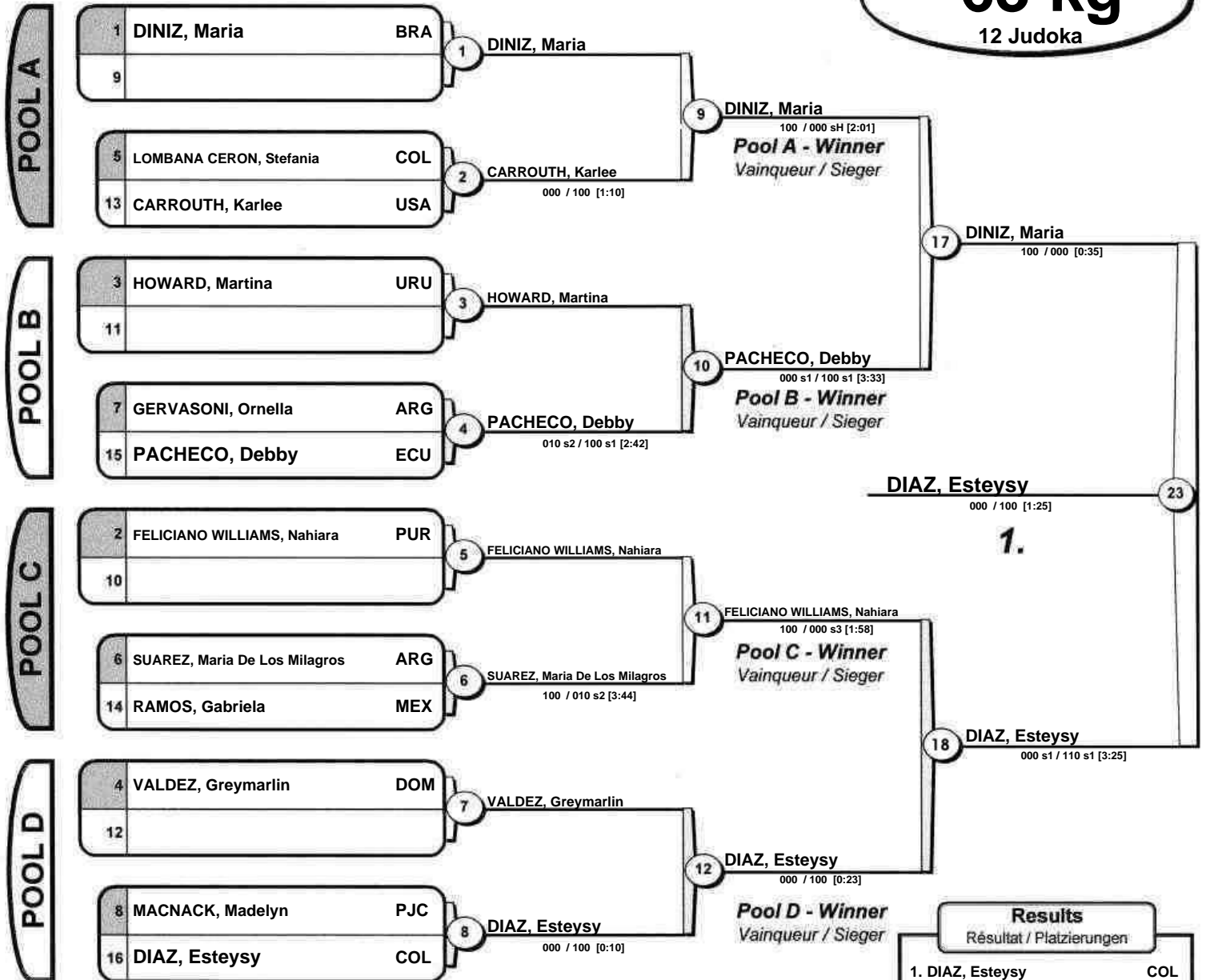

Results	
Résultat / Platzierungen	
1.	DIAZ, Esteysy COL
2.	DINIZ, Maria BRA
3.	CARROUTH, Karlee USA
3.	PACHECO, Debby ECU
5.	FELICIANO WILLIAMS, Nahia PUR
5.	VALDEZ, Greymarlin DOM
7.	HOWARD, Martina URU
7.	SUAREZ, Maria De Los Milagros ARG

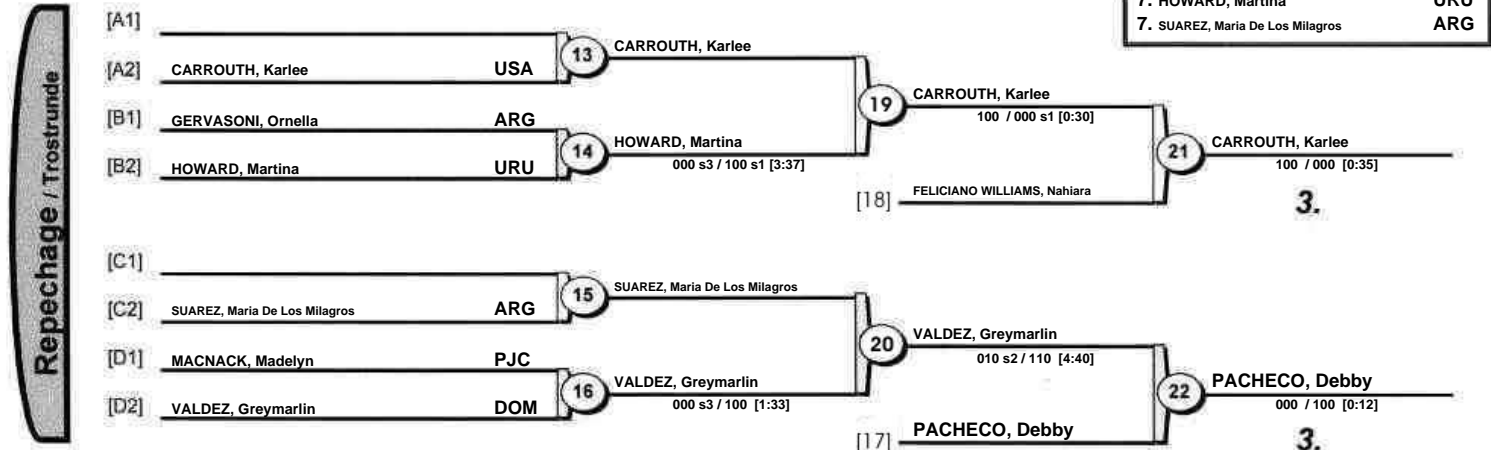



# Pan-American Cadet Championships 2019

(COL Cali, 19 July 2019)

## -70 kg

8 Judoka

POOL A

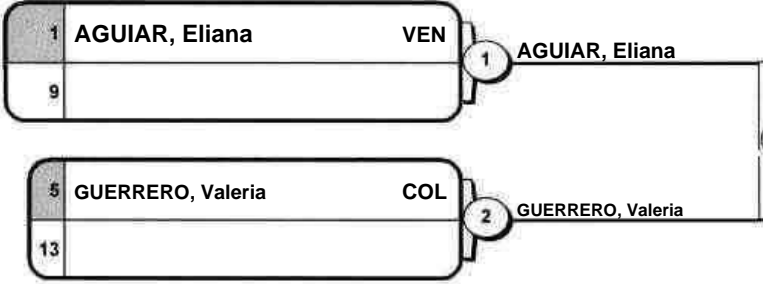

POOL B

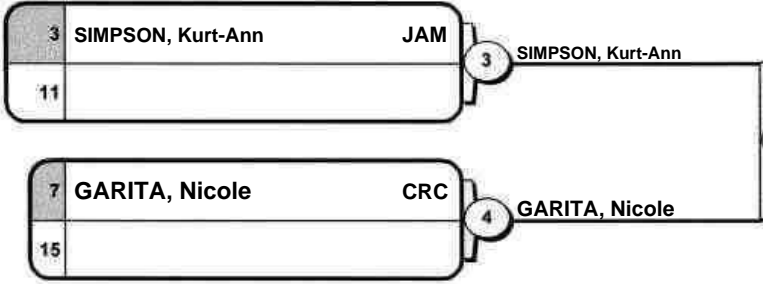

POOL C

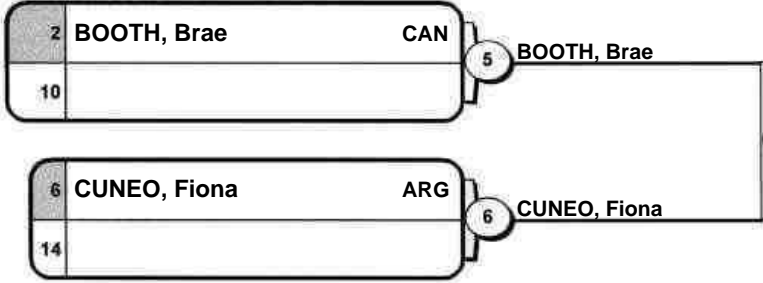

POOL D

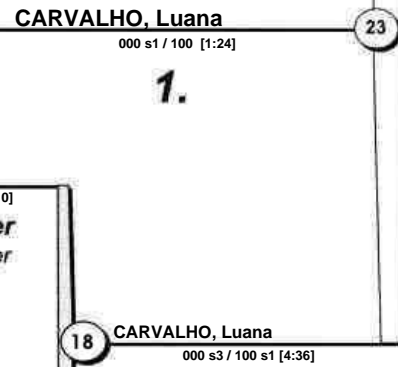
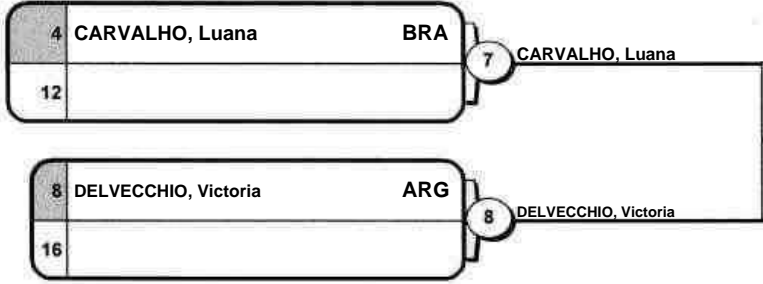

Results	
Résultat / Platzierungen	
1. CARVALHO, Luana	BRA
2. AGUIAR, Eliana	VEN
3. BOOTH, Brae	CAN
3. GARITA, Nicole	CRC
5. GUERRERO, Valeria	COL
5. CUNEO, Fiona	ARG
7. SIMPSON, Kurt-Ann	JAM
7. DELVECCHIO, Victoria	ARG

Repechage / Trostrunde

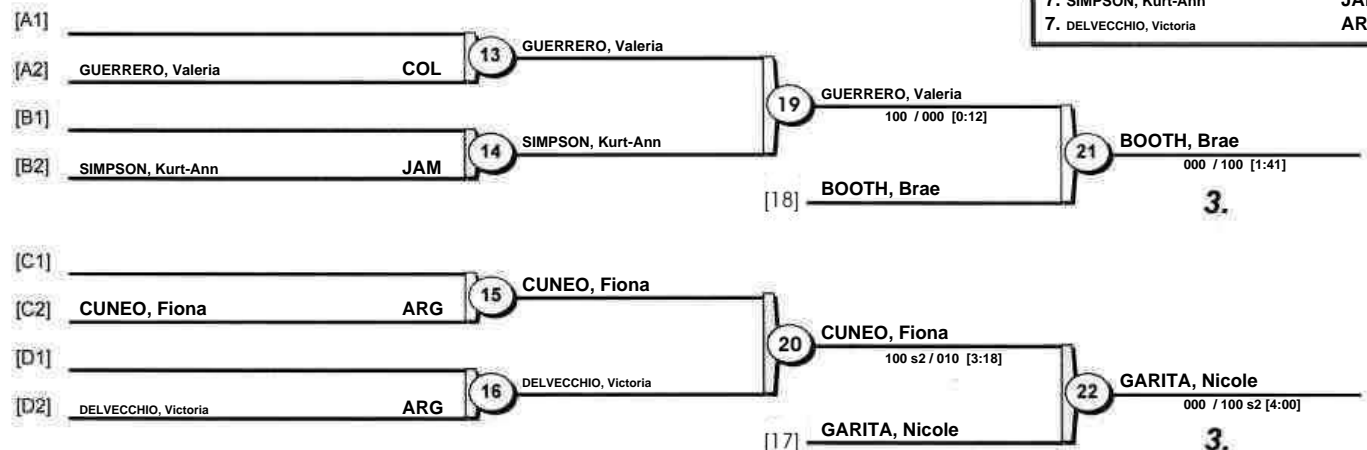



# Pan-American Cadet Championships 2019

(COL Cali, 19 July 2019)

## +70 kg

7 Judoka

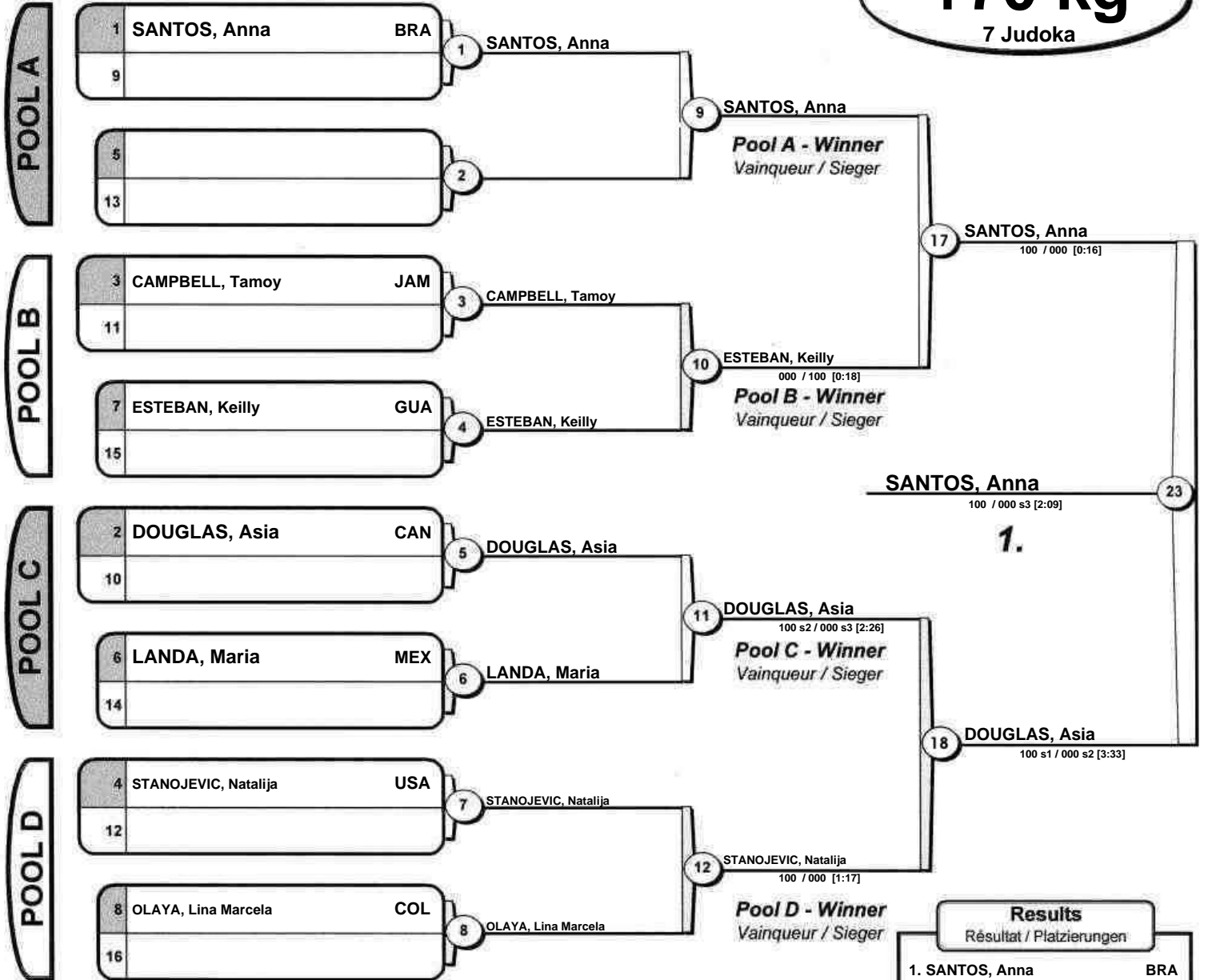

Results	
Résultat / Platzierungen	
1. SANTOS, Anna	BRA
2. DOUGLAS, Asia	CAN
3. STANOJEVIC, Natalija	USA
3. LANDA, Maria	MEX
5. CAMPBELL, Tamoy	JAM
5. ESTEBAN, Keilly	GUA
7.	
7. OLAYA, Lina Marcela	COL

