



Pan-American Open Bariloche 2020

(ARG Bariloche, 7-8 March 2020)

-60 kg

13 Judoka

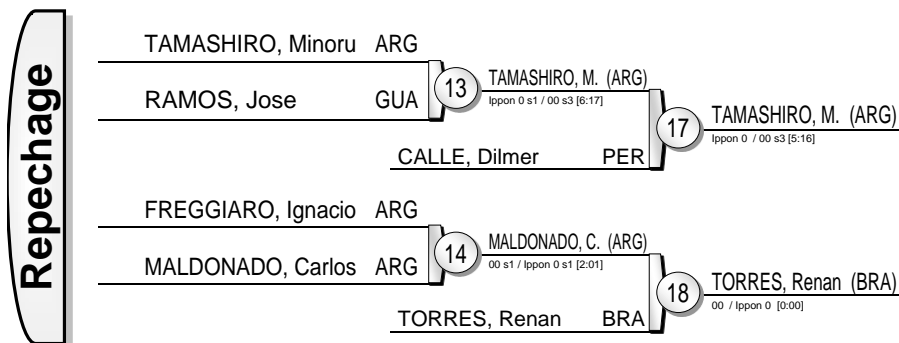

Results		
1.	MOROCHO, Steven	ECU
2.	AYALA, Juan	ECU
3.	TAMASHIRO, Minoru	ARG
3.	TORRES, Renan	BRA
5.	CALLE, Dilmer	PER
5.	MALDONADO, Carlos	ARG
7.	RAMOS, Jose	GUA
7.	FREGGIARO, Ignacio	ARG



Pan-American Open Bariloche 2020

(ARG Bariloche, 7-8 March 2020)

-66 kg

10 Judoka

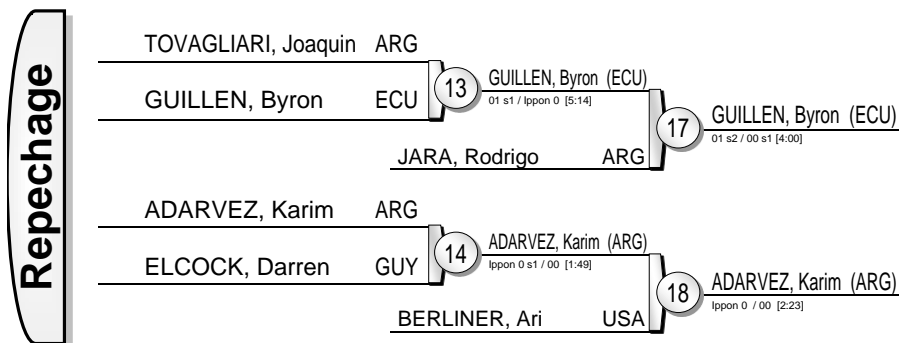

Results		
1.	LIMA, Willian	BRA
2.	PEREZ, Sebastian	CHI
3.	GUILLEN, Byron	ECU
3.	ADARVEZ, Karim	ARG
5.	JARA, Rodrigo	ARG
5.	BERLINER, Ari	USA
7.	TOVAGLIARI, Joaquin	ARG
7.	ELCOCK, Darren	GUY



Pan-American Open Bariloche 2020

(ARG Bariloche, 7-8 March 2020)

-73 kg

11 Judoka



Results		
1.	MARCELINO, Michael	BRA
2.	CHIBANA, Charles	BRA
3.	SALEM, Salama	USA
3.	DE LUCIA, Facundo	ARG
5.	TOSCANINI, Franco	CHI
5.	REIG ARNAU, Marc	AND
7.	RAMOS MARTINS, Fabian	AND
7.	DE RIDDER, Maarten	NZL



Pan-American Open Bariloche 2020

(ARG Bariloche, 7-8 March 2020)

-81 kg

9 Judoka

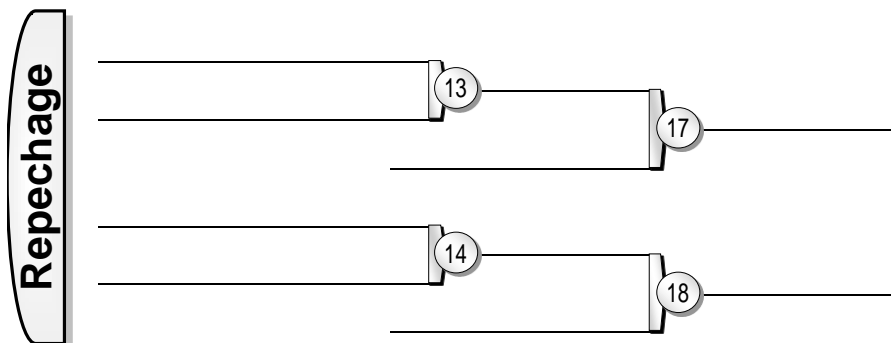
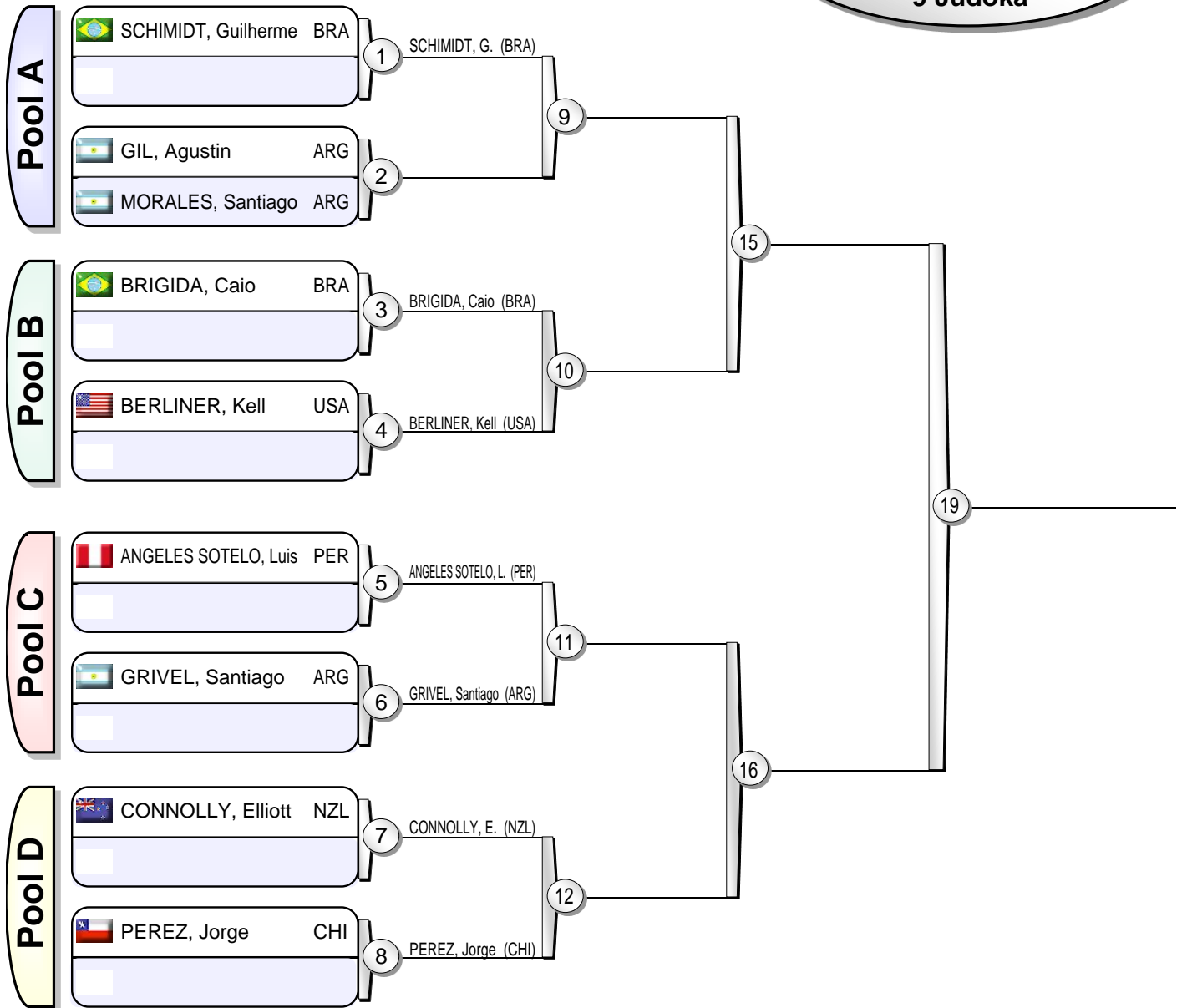

Results

- 1.
- 2.
- 3.
- 3.
- 5.
- 5.
- 7.
- 7.



Pan-American Open Bariloche 2020

(ARG Bariloche, 7-8 March 2020)

-90 kg

9 Judoka

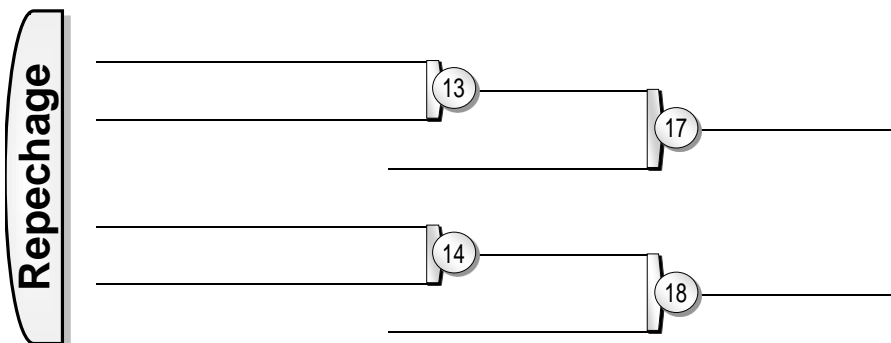

Results

- 1.
- 2.
- 3.
- 3.
- 5.
- 5.
- 7.
- 7.



Pan-American Open Bariloche 2020

(ARG Bariloche, 7-8 March 2020)

-100 kg

6 Judoka

Pool A

ARROYO OSORIO, Jose Luis PER

1 ARROYO OSORIO, J. (PER)

Pool B

BADUY, Habib ARG

PANNICCIA, Juan Ignacio ARG

2

Pool C

LIMA, Lucas BRA

3 LIMA, Lucas (BRA)

Pool D

ANGULO, Junior ECU

DARGOLTZ, Ivo ARG

4

7

8

11

Repechage

5

9

6

10

Results

- 1.
- 2.
- 3.
- 3.
- 5.
- 5.
- 7.
- 7.



Pan-American Open Bariloche 2020

(ARG Bariloche, 7-8 March 2020)

+100 kg

4 Judoka

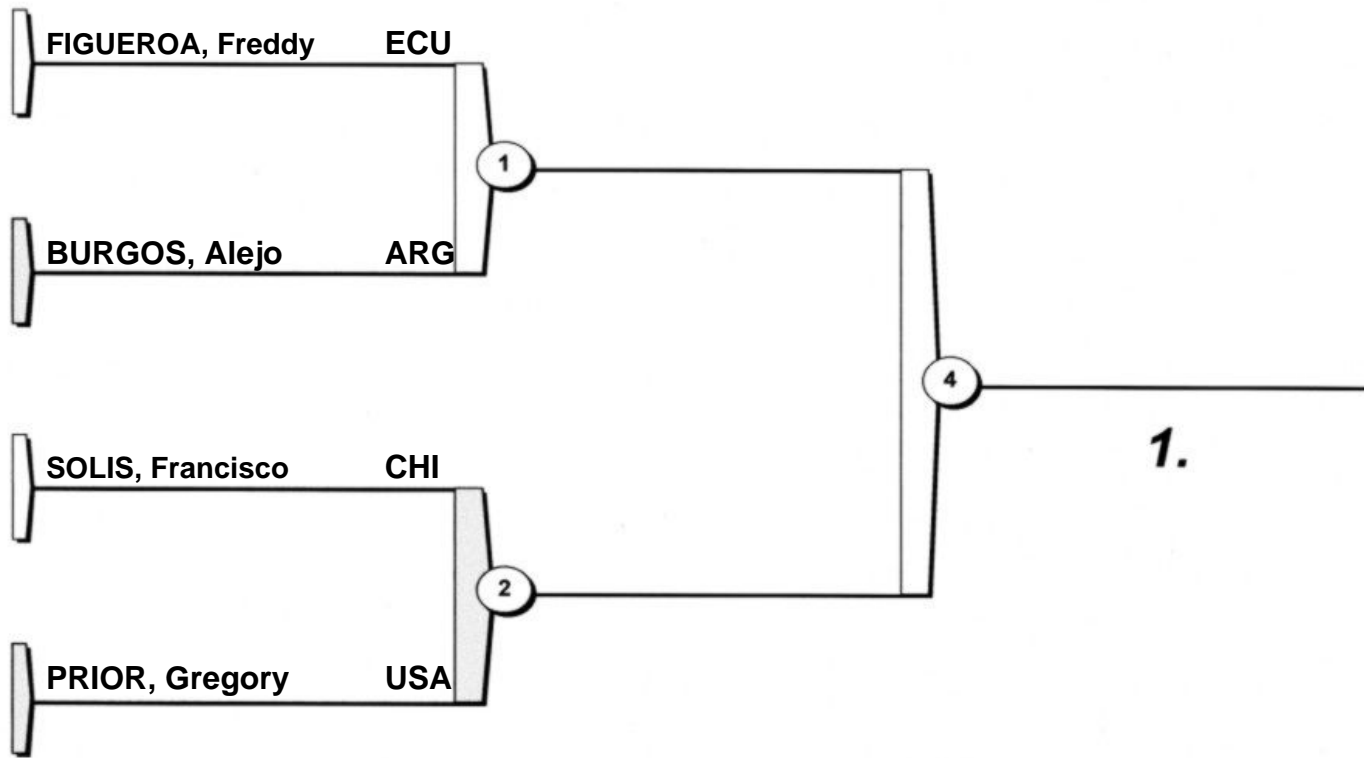

- 1.
- 2.
- 3.



Pan-American Open Bariloche 2020

(ARG Bariloche, 7-8 March 2020)

-48 kg

7 Judoka

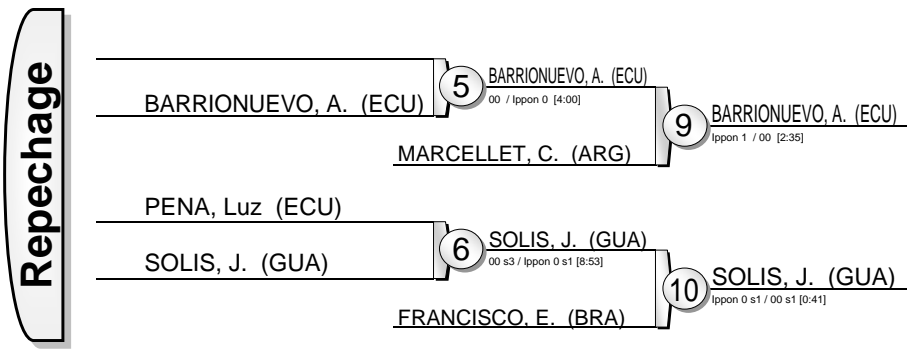
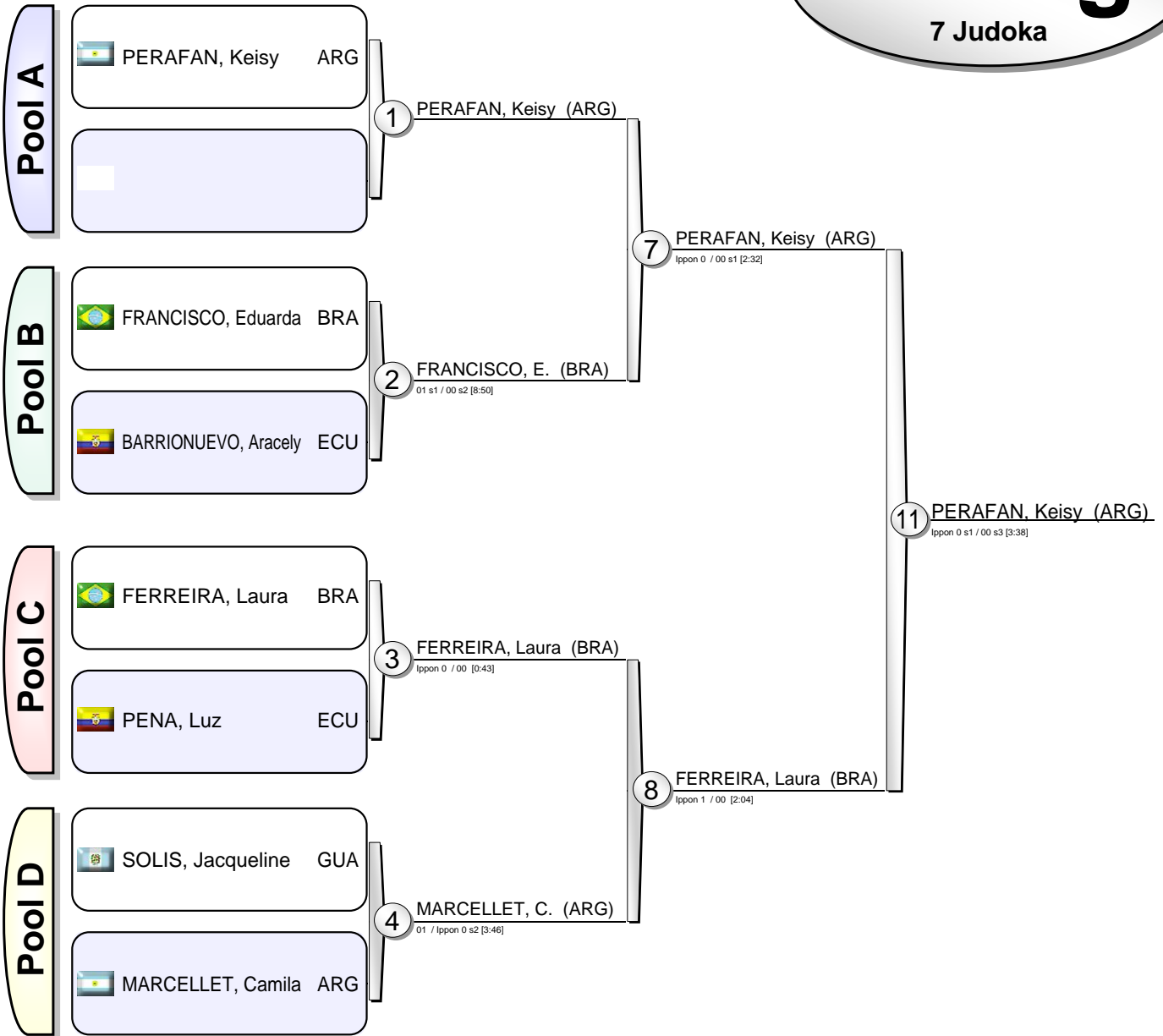

Results		
1.	PERAFAN, Keisy	ARG
2.	FERREIRA, Laura	BRA
3.	BARRIONUEVO, Aracely	ECU
3.	SOLIS, Jacqueline	GUA
5.	MARCELLET, Camila	ARG
5.	FRANCISCO, Eduarda	BRA
7.		
7.	PENA, Luz	ECU



Pan-American Open Bariloche 2020

(ARG Bariloche, 7-8 March 2020)

-52 kg

8 Judoka

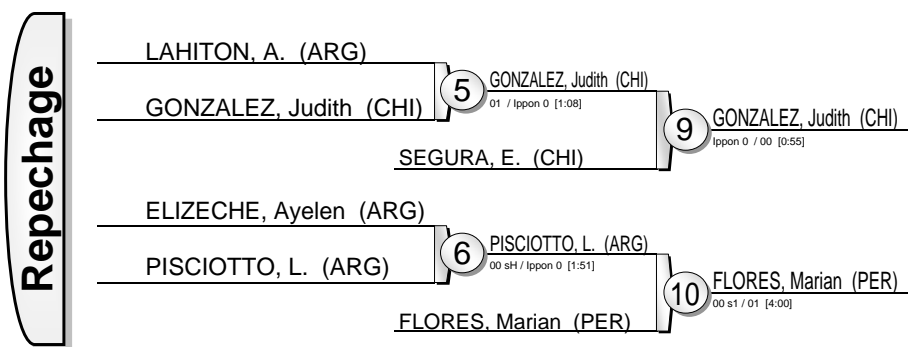
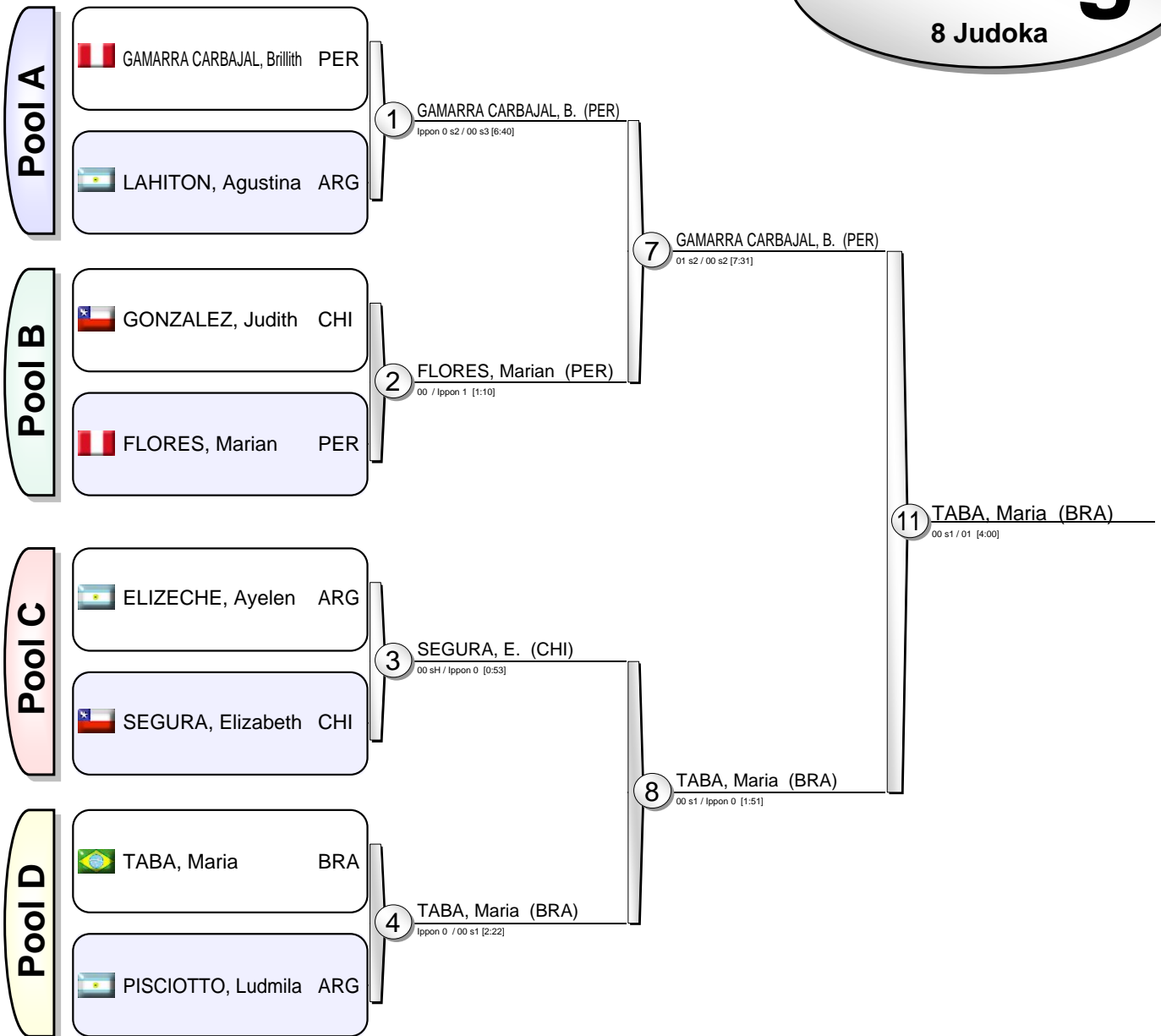

Results		
1.	TABA, Maria	BRA
2.	GAMARRA CARBAJAL, Brillith	PER
3.	GONZALEZ, Judith	CHI
3.	FLORES, Marian	PER
5.	SEGURA, Elizabeth	CHI
5.	PISCIOTTO, Ludmila	ARG
7.	LAHITON, Agustina	ARG
7.	ELIZECHE, Ayelen	ARG



Pan-American Open Bariloche 2020

(ARG Bariloche, 7-8 March 2020)

-57 kg

9 Judoka

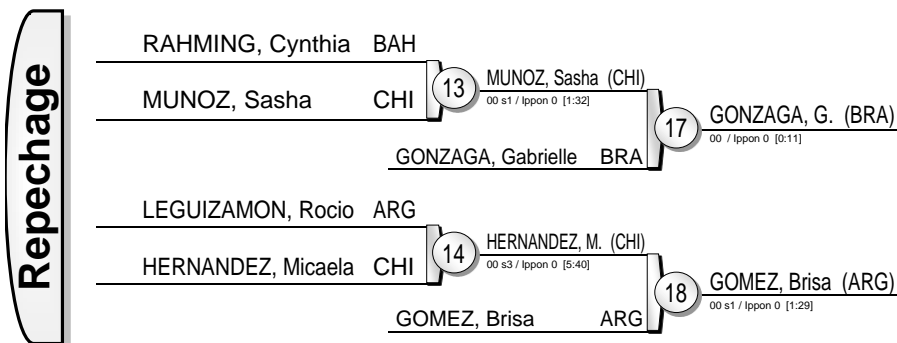

Results		
1.	VALENCIA, Karla	ECU
2.	GONZALEZ, Oritia	ARG
3.	GONZAGA, Gabrielle	BRA
3.	GOMEZ, Brisa	ARG
5.	MUNOZ, Sasha	CHI
5.	HERNANDEZ, Micaela	CHI
7.	RAHMING, Cynthia	BAH
7.	LEGUIZAMON, Rocio	ARG



Pan-American Open Bariloche 2020

(ARG Bariloche, 7-8 March 2020)

-63 kg

8 Judoka

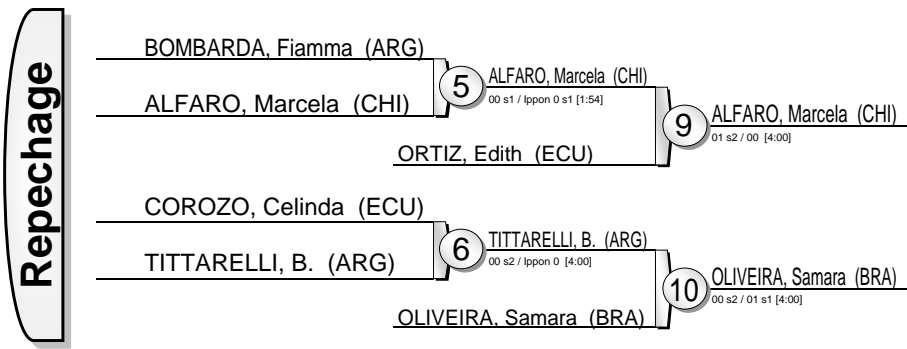
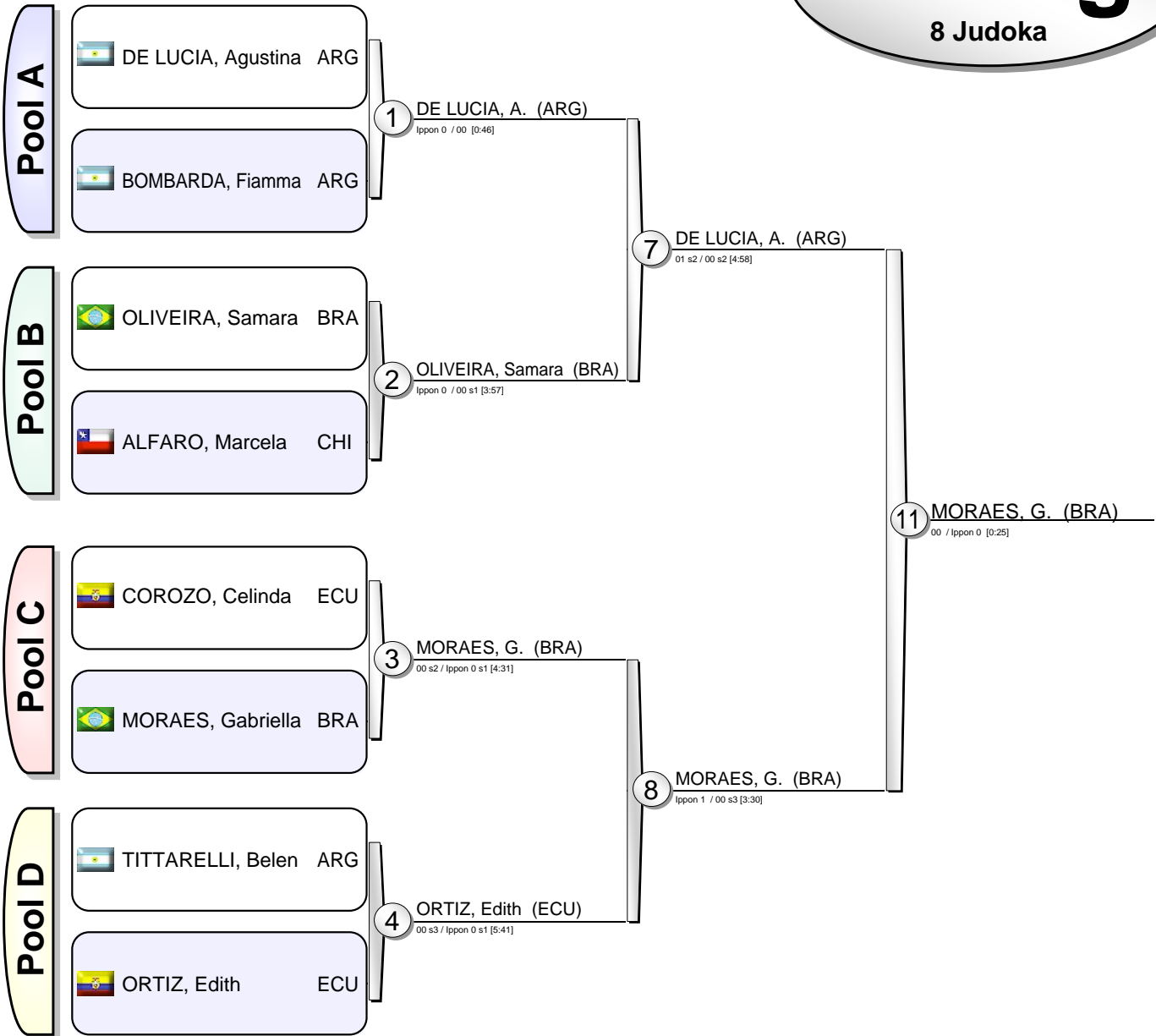

Results		
1.	MORAES, Gabriella	BRA
2.	DE LUCIA, Agustina	ARG
3.	ALFARO, Marcela	CHI
3.	OLIVEIRA, Samara	BRA
5.	ORTIZ, Edith	ECU
5.	TITTARELLI, Belen	ARG
7.	BOMBARDA, Fiamma	ARG
7.	COROZO, Celinda	ECU



Pan-American Open Bariloche 2020

(ARG Bariloche, 7-8 March 2020)

-70 kg

5 Judoka

			1	3	5	Wins	Scores
1	FIGUEROA, Mackarena	CHI				0	(0)
3	OLIVEIRA, Thalia	BRA				0	(0)
5	DELVECCHIO, Victoria	ARG				0	(0)

			2	4	Wins	Scores
2	MORALES FALCONI, Xsara	PER			0	(0)
4	MYERS, Melissa	USA			0	(0)

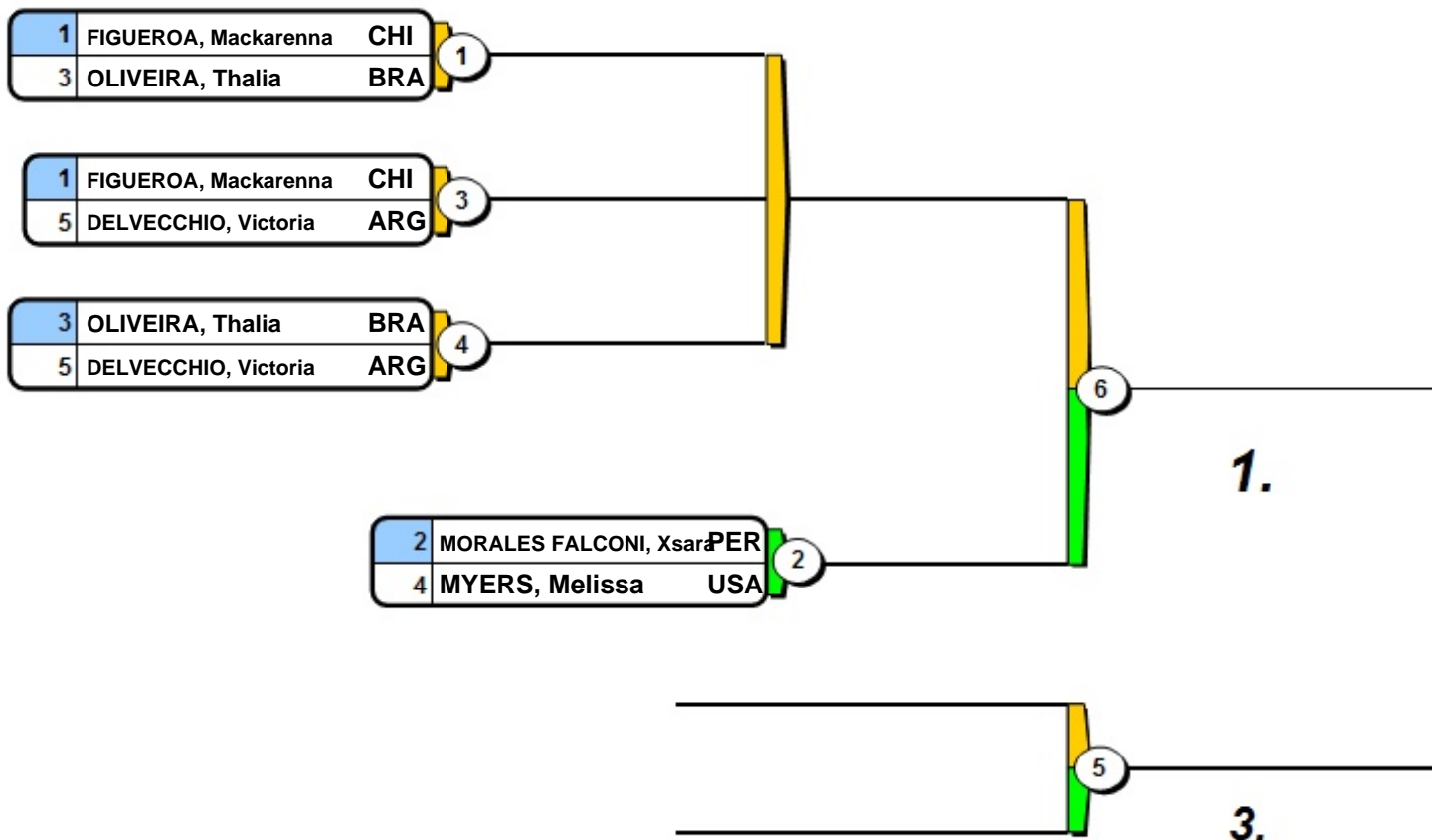

- 1.
- 2.
- 3.



Pan-American Open Bariloche 2020

(ARG Bariloche, 7-8 March 2020)

-78 kg

3 Judoka

			1	2	3		
1	BRANSER, Marie	COD				0 (0)	
2	CANTERO, Lucia	ARG				0 (0)	
3	STOUT, Nicole	USA				0 (0)	

1	BRANSER, Marie	COD	1	_____
2	CANTERO, Lucia	ARG		

1	BRANSER, Marie	COD	2	_____
3	STOUT, Nicole	USA		

2	CANTERO, Lucia	ARG	3	_____
3	STOUT, Nicole	USA		

1.

2.



Pan-American Open Bariloche 2020

(ARG Bariloche, 7-8 March 2020)

+78 kg

3 Judoka

			1	2	3		
1	WOOD, Gabriella	TTO				0 (0)	
2	BREDESTON, Amanda	ARG				0 (0)	
3	BOLIVAR GONZALES, Yuliana	PER				0 (0)	

1	WOOD, Gabriella	TTO	1
2	BREDESTON, Amanda	ARG	

1	WOOD, Gabriella	TTO	2
3	BOLIVAR GONZALES, Yuliana	PER	

2	BREDESTON, Amanda	ARG	3
3	BOLIVAR GONZALES, Yuliana	PER	

1.

2.